



NEW CONSTRUCTION PRODUCT GUIDE



TABLE OF CONTENTS

| | |
|----------------------------------|----|
| SERIES 105 SINGLE HUNG | 3 |
| SERIES 130 SINGLE HUNG | 7 |
| SERIES 150/160 SINGLE HUNG | 15 |
| SERIES 450/460 DOUBLE HUNG | 21 |
| HORIZONTAL SLIDERS | 27 |
| SERIES 105 SLIDERS | 28 |
| SERIES 130 SLIDERS | 30 |
| SERIES 151/161 SLIDERS | 37 |
| SERIES 451/461 SLIDERS | 41 |
| CASEMENT WINDOWS | 45 |
| AWNING | 50 |
| SLIDING PATIO DOORS | 52 |

Features:

- Removable bottom sash.
- Industry leading .01 cfm/ft. air infiltration performance.
- 1 1/4" Nail-fin setback for brick veneer construction and select stucco applications.
- Sweep lock helps provide a weather-tight seal and added security.
- Versatile half screen* installs easily from inside.
- Sloped sill reduces air infiltration and accommodates easy water run-off.
- Built-in accessory channels accommodate multiple installation options.
- Block and Tackle Balance System for ease of operation.
- Limited lifetime warranty provides reassuring peace of mind.
- Pre-punched integral nail-fin targets proper nail location for quick, easy installation.
- Modular sized so that rough opening widths for multiple units are easy to calculate:
 105 Single = 35.5"
 105 Twin = 71.5"
 105 Triple = 107.5"
- DP Ratings:
 R-50 (window size tested 36" x 96")
 R-35 (window size tested 44" x 96")
 R-25 (window size tested 48" x 96")
- Jamb depth: 2.625".

Custom Options:

- Low-E Glass.
- Low-E Glass with Argon Gas.
- Ultra Low-E Glass with Argon Gas.
- 5/8" or 3/4" flat, 5/8" or 1" contoured, 5/8" contoured valance grids available.
- Almond color.
- Factory mulling of twins, triples and architectural shapes.
- Custom sizes available.
- Window Opening Control Device (WOCD) for fall prevention (field applied).
- Paintable or stainable foamed PVC jamb extensions (4 9/16" and 6 9/16").

Materials:

- Frame and sash are maintenance free, color stabilized solid vinyl (PVC).
- The screen is comprised of rolled form aluminum frame and fiberglass mesh.
- Glazing method: Glazing tape.

Structural Performance

| SERIES/MODEL | TEST SIZE | AIR (cfm/ft ²) | DESIGN PRESSURE |
|--------------|-----------|----------------------------|-----------------|
| 105 SH | 36 X 96 | 0.1 | H-LC50 |
| 105 CHS SHTW | 84 X 84 | 0.02 | H-LC35 |
| 105 CHS SHTR | 108 X 84 | 0.17 | H-LC40 |

Thermal Performance

| GLASS/GRID | U-Value | SHGC |
|------------------------------|---------|------|
| SS Clear Glass No Grid | 0.49 | 0.66 |
| DS Clear Glass No Grid | 0.49 | 0.64 |
| SS Low-E Glass No Grid | 0.34 | 0.31 |
| DS Low-E Glass No Grid | 0.34 | 0.31 |
| SS Low-E/Argon Glass No Grid | 0.31 | 0.31 |
| DS Low-E/Argon Glass No Grid | 0.30 | 0.31 |
| SS Ultra Low-E No Grid | 0.34 | 0.23 |
| DS Ultra Low-E No Grid | 0.34 | 0.23 |
| SS Ultra Low-E/Argon No Grid | 0.30 | 0.23 |
| DS Ultra Low-E/Argon No Grid | 0.30 | 0.23 |

| GLASS/GRID | U-Value | SHGC |
|--------------------------------|---------|------|
| SS Clear Glass with Grid | 0.49 | 0.59 |
| DS Clear Glass with Grid | 0.49 | 0.58 |
| SS Low-E Glass with Grid | 0.34 | 0.28 |
| DS Low-E Glass with Grid | 0.34 | 0.28 |
| SS Low-E/Argon Glass with Grid | 0.31 | 0.28 |
| DS Low-E/Argon Glass with Grid | 0.30 | 0.28 |
| SS Ultra Low-E with Grid | 0.34 | 0.21 |
| DS Ultra Low-E with Grid | 0.34 | 0.21 |
| SS Ultra Low-E/Argon with Grid | 0.30 | 0.21 |
| DS Ultra Low-E/Argon with Grid | 0.30 | 0.21 |

SERIES 105 SINGLE HUNG

| SERIES | 105 SH |
|---------------------------|------------------------|
| VINYL WALL THICKNESS | 0.062" |
| GLASS THICKNESS | 0.750" |
| JAMB THICKNESS | 2.625" |
| FRAME WIDTH | 1.3125" |
| NAILING FIN LENGTH | 1.125" |
| NAIL FIN SETBACK | 1.375" |
| EGRESS WIDTH | (WW) - 2.625" |
| EGRESS HEIGHT (WITH SASH) | (WH/2) - 4.75" |
| SCREEN WIDTH | (WW) - 1.4375" |
| SCREEN HEIGHT | (WH/2) - .4375" |
| OPTIONS GLASS: | |
| CLEAR (STANDARD) | • |
| LOW-E ARGON | • |
| ULTRA LOW-E WITH ARGON | • |
| OBSCURE | • |
| TEMPERED | • |
| DOUBLE STRENGTH | • |
| OPTIONS GAS: | |
| ARGON | • |
| AVAILABLE SPECIAL SHAPES: | |
| FULL ROUNDS | QUARTER ROUNDS |
| HALF ROUNDS | ELLIPTICALS |
| OCTAGONS | PENTAGONS |
| TRAPEZOIDS | TRIANGLES |
| HALF EYEBROWS | EYEBROWS |
| COLONIAL ARCHES | COLONIAL FLANKERS |
| OVALS | COLONIAL ARCH FLANKERS |
| OPERABLE EYEBROWS | OPERABLE HALF EYEBROWS |

(WW) = WINDOW WIDTH

(WH) = WINDOW HEIGHT

SERIES 105 SINGLE HUNG

Series 105 SH vertical diagram

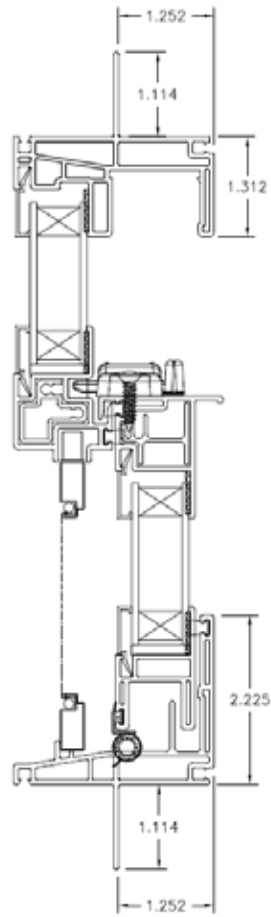

Series 105 SH horizontal diagram

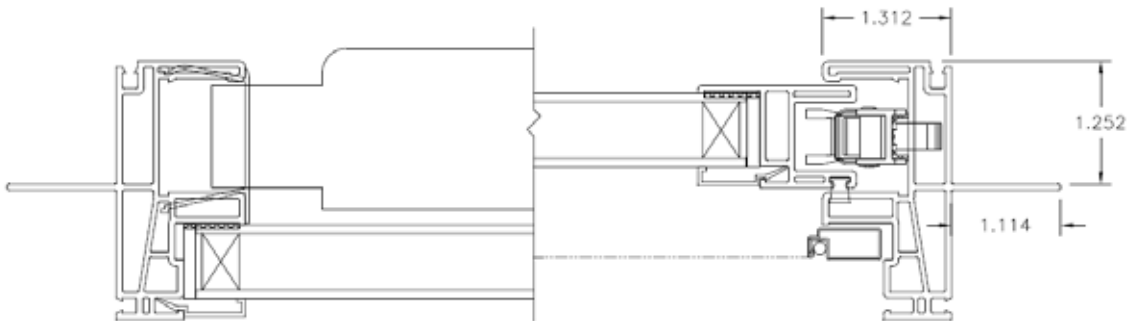

Mulled Units:

Factory mulling of twins, triples and special shapes provides easier installation without extra labor or material costs.

Reinforcement is available for added strength in factory mulled units.

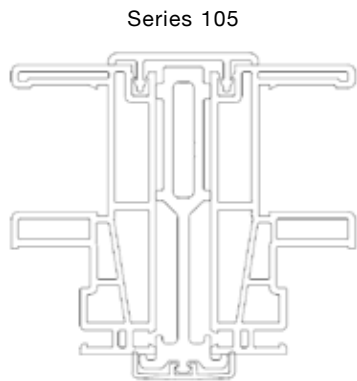

Recommended Rough Opening:

Width = Window Width (WW) + 1/2"

Height = Window Height (WH) + 1/2"

Foamed PVC Jamb Extension:

The interior foamed PVC jamb extension is available in pre-primed or stainable version for your convenience and ease of installation for a frame thickness of either 4 9/16" or 6 9/16".

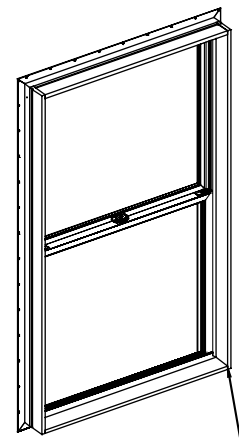

WOOD EXTENSION 3" X 5/8"
OVERALL WALL THICKNESS = 4 9/16"

SERIES 130 SINGLE HUNG

Features:

- Bottom sash tilts in for easy cleaning from inside.
- Aluminum half screen comes standard.*
- Block and Tackle balance system for easy sash movement.
- Warm-Edge spacer system provides energy saving thermal performance.
- DP-50 rating (window size tested 53" x 77").
- Aluminum reinforcement standard in lock & meeting rails and sash stiles.
- Dual Sweep locks (standard at 27 1/4" and above) help provide a weather-tight seal and added security.
- Step sill design combines water run-off and aesthetic features of a sloped sill with the structural strength and internal drainage system of a pocket sill.
- Jamb depth: 3".
- Limited lifetime warranty.

Select from four frame types:

- Front Flange Only
- Nail Fin Only (no J-Channel)
- J-Channel (nail fin & front flange)
- Box Frame (no nail fin & no front flange)

Custom Options:

- Low-E Glass.
- Low-E Glass with Argon Gas.
- Ultra Low-E Glass with Argon Gas.
- 5/8" or 3/4" flat, 5/8" or 1" contoured and 1 1/8" Simulated Divide Lite (SDL) available.
- Non-reflective Low-E Glass and Non-reflective Low-E Glass with Argon Gas.
- Almond and Clay vinyl colors.
- Bronze and Black exterior laminate (white interior only).
- Nine painted exterior colors (white interior only).
- Double strength and obscure glass.
- Oriel style.
- Window Opening Control Device (WOCD) for fall prevention (factory applied).
- Factory mulling and Factory Prepared mulling.

- Commodity sizing available.
- Custom sizes available.
- Charcoal Aluminum half screen.

Materials:

- Frame and sash are maintenance free, color stabilized solid vinyl (PVC).
- The screen is comprised of rolled form aluminum frame and fiberglass mesh.

Structural Performance

| SERIES/MODEL | TEST SIZE | AIR (cfm/ft ²) | DESIGN PRESSURE |
|-----------------------|-----------|----------------------------|-----------------|
| 130 SH | 53 X 77 | 0.13 | H-LC50 |
| 130 SH WITH TRANSOM | 48 X 109 | 0.17 | H-LC50 |
| 130 SHTW WITH TRANSOM | 73 X 109 | 0.13 | H-LC50 |
| 130 SHTR | 109 X 77 | 0.19 | H-LC50 |
| 130 SHTW | 97 X 84 | 0.13 | H-LC40 |

Thermal Performance

| GLASS/GRID | U-Value | SHGC |
|------------------------------------|---------|------|
| SS Clear Glass No Grid | 0.49 | 0.63 |
| DS Clear Glass No Grid | 0.49 | 0.62 |
| SS Low-E Glass No Grid | 0.36 | 0.30 |
| DS Low-E Glass No Grid | 0.35 | 0.30 |
| SS Low-E/Argon Glass No Grid | 0.32 | 0.30 |
| DS Low-E/Argon Glass No Grid | 0.32 | 0.29 |
| SS Ultra Low-E/Argon No Grid | 0.29 | 0.22 |
| DS Ultra Low-E/Argon No Grid | 0.29 | 0.22 |
| SS Turtle Code Low-E No Grid | 0.36 | 0.21 |
| DS Turtle Code Low-E No Grid | 0.36 | 0.21 |
| SS Turtle Code Low-E/Argon No Grid | 0.33 | 0.20 |
| DS Turtle Code Low-E/Argon No Grid | 0.33 | 0.20 |
| SS Clear Glass with Grid | 0.49 | 0.57 |
| DS Clear Glass with Grid | 0.49 | 0.55 |
| SS Low-E Glass with Grid | 0.36 | 0.27 |
| DS Low-E Glass with Grid | 0.35 | 0.27 |

| GLASS/GRID | U-Value | SHGC |
|------------------------------------|---------|------|
| SS Low-E/Argon Glass with Grid | 0.32 | 0.27 |
| SS Ultra Low-E/Argon with Grid | 0.29 | 0.20 |
| DS Ultra Low-E/Argon with Grid | 0.29 | 0.20 |
| DS Low-E/Argon Glass with Grid | 0.36 | 0.19 |
| SS Turtle Code Low-E No Grid | 0.36 | 0.19 |
| DS Turtle Code Low-E No Grid | 0.33 | 0.19 |
| SS Turtle Code Low-E/Argon No Grid | 0.33 | 0.18 |
| DS Turtle Code Low-E/Argon No Grid | 0.49 | 0.50 |
| SS Clear Glass with SDL | 0.49 | 0.49 |
| DS Clear Glass with SDL | 0.36 | 0.24 |
| SS Low-E Glass with SDL | 0.35 | 0.24 |
| DS Low-E Glass with SDL | 0.32 | 0.24 |
| SS Low-E/Argon Glass with SDL | 0.29 | 0.20 |
| SS Ultra Low-E/Argon with SDL | 0.29 | 0.20 |
| DS Ultra Low-E/Argon with SDL | 0.36 | 0.17 |
| DS Low-E/Argon Glass with SDL | 0.36 | 0.17 |
| SS Turtle Code Low-E with SDL | 0.33 | 0.17 |
| DS Turtle Code Low-E with SDL | 0.33 | 0.17 |

SERIES 130 SINGLE HUNG

| SERIES | 130 SH |
|---|------------------------------|
| VINYL WALL THICKNESS | 0.060" |
| GLASS THICKNESS | 0.750" (19.05MM) |
| JAMB THICKNESS | 3" |
| FRAME WIDTH | 2.412" |
| NAILING FIN LENGTH | 1.365" |
| NAIL FIN SETBACK | 1.9375" |
| "J" CHANNEL DEPTH | .625" (15.88MM) (N/A ON 160) |
| EGRESS WIDTH | (WW) - 4.75" |
| EGRESS HEIGHT (WITH SASH) | (WH/2) - 3" |
| SCREEN WIDTH | (WW) - 3.6875" |
| SCREEN HEIGHT | (WH/2) - 1.8125" |
| OPTIONS GLASS: | |
| CLEAR (STANDARD) | • |
| LOW-E ARGON | • |
| ULTRA LOW-E WITH ARGON | • |
| NON-REFLECTIVE LOW-E GLASS | • |
| NON-REFLECTIVE LOW-E GLASS WITH ARGON GAS | • |
| OBSCURE | • |
| TEMPERED | • |
| DOUBLE STRENGTH | • |
| OPTIONS GAS: | |
| ARGON | • |
| AVAILABLE SPECIAL SHAPES: | |
| FULL ROUNDS | QUARTER ROUNDS |
| HALF ROUNDS | ELLIPTICALS |
| OCTAGONS | PENTAGONS |
| TRAPEZOIDS | TRIANGLES |
| HALF EYEBROWS | EYEBROWS |
| COLONIAL ARCHES | COLONIAL FLANKERS |
| | COLONIAL ARCH FLANKERS |

(WW) = WINDOW WIDTH

(WH) = WINDOW HEIGHT

Series 130 SH vertical diagram

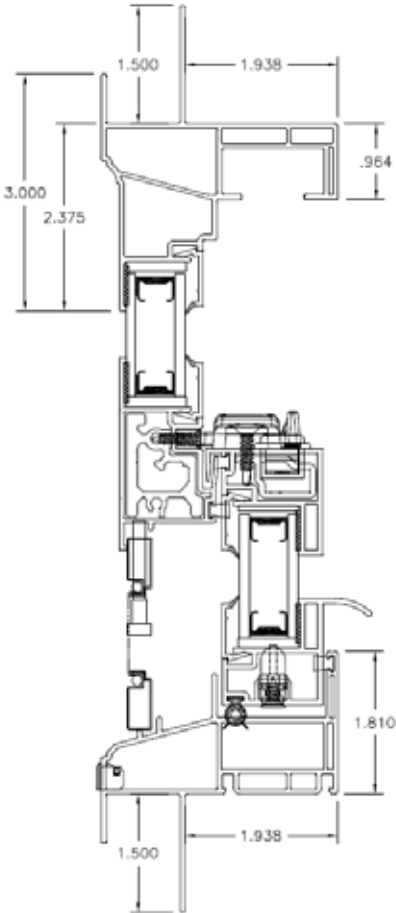

Series 130 SH horizontal diagram

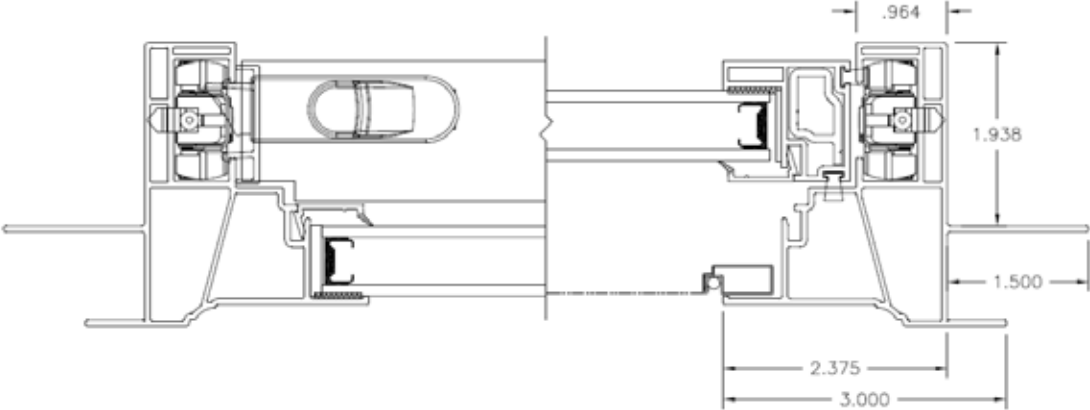

SERIES 130 SINGLE HUNG

Series 130 SH
vertical diagram
Box

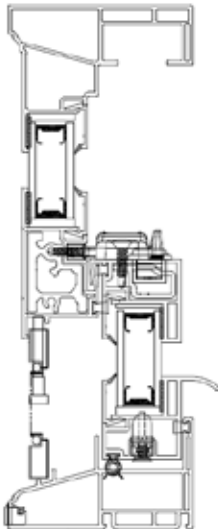

Series 130 SH
vertical diagram
Fin & Flange

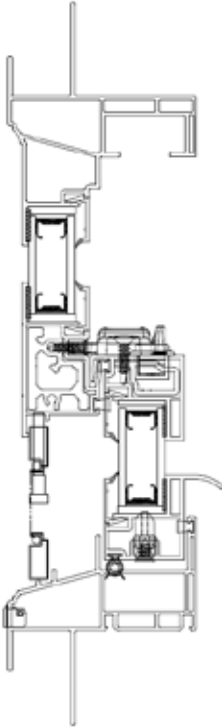

Series 130 SH
vertical diagram
Fin Only

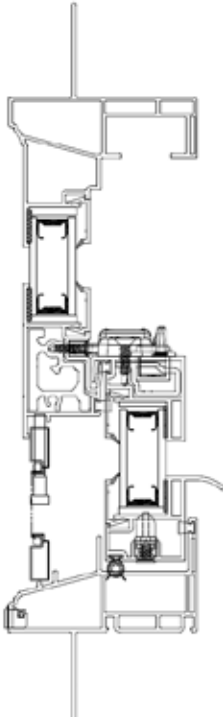

Series 130 SH
vertical diagram
Flange Only

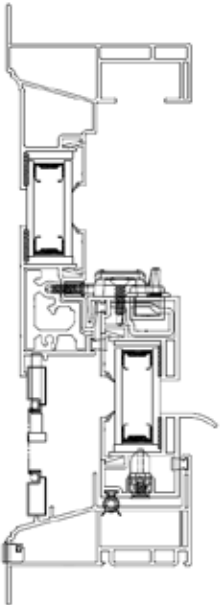

Mulled Units:

Factory mulling of twins, triples and special shapes provides easier installation without extra labor or material costs.

Series 130

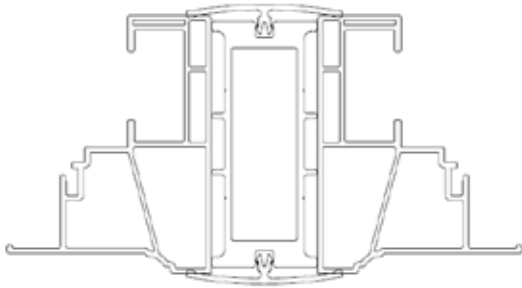

Recommended Rough Opening for Wood Frame Openings:

Width = Window Width (WW) + 1/2"

Height = Window Height (WH) + 1/2"

SERIES 130 SINGLE HUNG





































































SERIES 130 SINGLE HUNG SIZE CHART

SERIES 130 SINGLE HUNG

*Meets egress of: Clear operable area of ≥ 5.7 sq. ft.

Clear operable width of $\geq 20"$

Clear operable height of $\geq 24"$

| ROUGH OPENING | 24" | 28" | 30" | 32" | 36" | 40" | 42" | 44" | 48" |
|---------------------------------|--|--|--|--|--|--|--|--|--|
| EXACT SIZE | 23.5" | 27.5" | 29.5" | 31.5" | 35.5" | 39.5" | 41.5" | 43.5" | 47.5" |
| EGRESS WIDTH | 18.75" | 22.75" | 24.75" | 26.75" | 30.75" | 34.75" | 36.75" | 38.75" | 42.75" |
| 36" 35.5" 18.8125" HEIGHT |  2030 |  2430 |  2630 |  2830 |  3030 |  3430 |  3630 |  3830 | |
| 44" 43.5" 17.8125" HEIGHT |  2038 |  2438 |  2638 |  2838 |  3038 |  3438 |  3638 |  3838 | |
| 48" 47.5" 19.8125" HEIGHT |  2040 |  2440 |  2640 |  2840 |  3040 |  3440 |  3640 |  3840 | |
| 52" 51.5" 21.8125" HEIGHT |  2044 |  2444 |  2644 |  2844 |  3044 |  3444 |  3644 |  3844 | |
| 60" 59.5" 25.8125" HEIGHT |  2050 |  2450 |  2650 |  2850 |  3050* |  3450* |  3650* |  3850* |  4050* |
| 62" 61.5" 26.8125" HEIGHT |  2052 |  2452 |  2652 |  2852 |  3052* |  3452* |  3652* |  3852* |  4052* |
| 66" 65.5" 28.8125" HEIGHT |  2056 |  2456 |  2656 |  2856 |  3056* |  3456* |  3656* |  3856* |  4056* |
| 72" 71.5" 31.8125" HEIGHT |  2060* |  2460* |  2660* |  2860* |  3060* |  3460* |  3660* |  3860* |  4060* |























SERIES 130 SINGLE HUNG

SERIES 130 SINGLE HUNG COMMODITY SIZE CHARTS

SERIES 130 SINGLE HUNG

*Meets egress of: Clear operable area of ≥ 5.7 sq. ft. Clear operable width of $\geq 20"$

Clear operable height of $\geq 24"$

| MASONRY OPENING | 19 7/8" | 27 1/4" | 37 3/4" | 53 3/4" |
|-----------------|---|---|---|---|
| TIP TO TIP | 19 3/8" | 26 3/4" | 37 1/4" | 53 3/8" |
| EXACT SIZE | 18 1/8" | 25 1/2" | 36" | 52 1/8" |
| 26" |  |  |  |  |
| 38 3/8" |  |  |  |  |
| 50 5/8" |  |  |  |  |
| 63" |  |  |  |  |
| 72" |  |  |  |  |
| 76 3/4" |  |  |  | |

SERIES 130 SINGLE HUNG

| Commodity Size | Masonry Opening Size | Tip to Tip Size | Exact Size |
|----------------|----------------------|-----------------|-----------------|
| 12 | 19 7/8 x 26 | 19 3/8 x 26 1/4 | 18 1/8 x 25 |
| 13 | 19 7/8 x 38 3/8 | 19 3/8 x 38 5/8 | 18 1/8 x 37 3/8 |
| 14 | 19 7/8 x 50 5/8 | 19 3/8 x 50 7/8 | 18 1/8 x 49 5/8 |
| 15 | 19 7/8 x 63 | 19 3/8 x 63 1/4 | 18 1/8 x 62 |
| 16 | 19 7/8 x 72 | 19 3/8 x 72 1/4 | 18 1/8 x 71 |
| 1 x 76 3/4 | 19 7/8 x 76 3/4 | 19 3/8 x 77 | 18 1/8 x 75 3/4 |
| 1/32 | 27 1/4 x 26 | 26 3/4 x 26 1/4 | 25 1/2 x 25 |
| 1/33 | 27 1/4 x 38 3/8 | 26 3/4 x 38 5/8 | 25 1/2 x 37 3/8 |
| 1/34 | 27 1/4 x 50 5/8 | 26 3/4 x 50 7/8 | 25 1/2 x 49 5/8 |
| 1/35 | 27 1/4 x 63 | 26 3/4 x 63 1/4 | 25 1/2 x 62 |
| 1/36 | 27 1/4 x 72 | 26 3/4 x 72 1/4 | 25 1/2 x 71 |
| 1/3 x 76 3/4 | 27 1/4 x 76 3/4 | 26 3/4 x 77 | 25 1/2 x 75 3/4 |

| Commodity Size | Masonry Opening Size | Tip to Tip Size | Exact Size |
|----------------|----------------------|-----------------|-----------------|
| 22 | 37 3/4 x 26 | 37 1/4 x 26 1/4 | 36 x 25 |
| 23 | 37 3/4 x 38 3/8 | 37 1/4 x 38 5/8 | 36 x 37 3/8 |
| 24 | 37 3/4 x 50 5/8 | 37 1/4 x 50 7/8 | 36 x 49 5/8 |
| 25 | 37 3/4 x 63 | 37 1/4 x 63 1/4 | 36 x 62 |
| 26 | 37 3/4 x 72 | 37 1/4 x 72 1/4 | 36 x 71 |
| 2 x 76 3/4 | 37 3/4 x 76 3/4 | 37 1/4 x 77 | 36 x 75 3/4 |
| 32 | 53 3/4 x 26 | 53 3/8 x 26 1/4 | 52 1/8 x 25 |
| 33 | 53 3/4 x 38 3/8 | 53 3/8 x 38 5/8 | 52 1/8 x 37 3/8 |
| 34 | 53 3/4 x 50 5/8 | 53 3/8 x 50 7/8 | 52 1/8 x 49 5/8 |
| 35 | 53 3/4 x 63 | 53 3/8 x 63 1/4 | 52 1/8 x 62 |
| 36 | 53 3/4 x 72 | 53 3/8 x 72 1/4 | 52 1/8 x 71 |

SERIES 130 SINGLE HUNG

SERIES 130 SINGLE HUNG EGRESS CHARTS

SERIES 130 SINGLE HUNG EGRESS SQUARE FOOTAGE

| NOM. SIZE | EGRESS TOTAL SQUARE FEET (WITH SASH) |
|-----------|--------------------------------------|
| 2030 | 1.92 |
| 2038 | 2.44 |
| 2040 | 2.70 |
| 2044 | 2.96 |
| 2050 | 3.48 |
| 2052 | 3.61 |
| 2056 | 3.87 |
| 2060 | 4.26 |
| 2430 | 2.33 |
| 2438 | 2.96 |
| 2440 | 3.28 |
| 2444 | 3.59 |
| 2450 | 4.23 |
| 2452 | 4.38 |
| 2456 | 4.70 |
| 2460 | 5.17 |
| 2630 | 2.54 |
| 2638 | 3.22 |
| 2640 | 3.57 |
| 2644 | 3.91 |
| 2650 | 4.60 |
| 2652 | 4.77 |
| 2656 | 5.11 |
| 2660 | 5.63 |

| NOM. SIZE | EGRESS TOTAL SQUARE FEET (WITH SASH) |
|-----------|--------------------------------------|
| 2830 | 2.74 |
| 2838 | 3.48 |
| 2840 | 3.85 |
| 2844 | 4.23 |
| 2850 | 4.97 |
| 2852 | 5.15 |
| 2856 | 5.53 |
| 2860 | 6.08 |
| 3030 | 3.15 |
| 3038 | 4.00 |
| 3040 | 4.43 |
| 3044 | 4.86 |
| 3050 | 5.71 |
| 3052 | 5.93 |
| 3056 | 6.35 |
| 3060 | 6.99 |
| 3430 | 3.56 |
| 3438 | 4.52 |
| 3440 | 5.01 |
| 3444 | 5.49 |
| 3450 | 6.46 |
| 3452 | 6.70 |
| 3456 | 7.18 |
| 3460 | 7.90 |

| NOM. SIZE | EGRESS TOTAL SQUARE FEET (WITH SASH) |
|-----------|--------------------------------------|
| 3630 | 3.76 |
| 3638 | 4.79 |
| 3640 | 5.30 |
| 3644 | 5.81 |
| 3650 | 6.83 |
| 3652 | 7.08 |
| 3656 | 7.59 |
| 3660 | 8.36 |
| 3830 | 3.97 |
| 3838 | 5.05 |
| 3840 | 5.58 |
| 3844 | 6.12 |
| 3850 | 7.20 |
| 3852 | 7.47 |
| 3856 | 8.01 |
| 3860 | 8.81 |
| 4030 | 4.38 |
| 4038 | 5.57 |
| 4040 | 6.16 |
| 4044 | 6.75 |
| 4050 | 7.94 |
| 4052 | 8.24 |
| 4056 | 8.83 |
| 4060 | 9.72 |

130 SINGLE HUNG COMMODITY EGRESS CHART

| Commodity Size | Tip to Tip Size | Exact Size | With Sash | Sq. Feet |
|-----------------|-----------------|-----------------|-----------------|----------|
| 12 | 19 1/4 x 26 1/4 | 18 1/8 x 25 | 13 3/8 x 9 4/8 | 0.88 |
| 13 | 19 1/4 x 38 5/8 | 18 1/8 x 37 3/8 | 13 3/8 x 15 6/8 | 1.46 |
| 14 | 19 1/4 x 50 7/8 | 18 1/8 x 49 5/8 | 13 3/8 x 21 7/8 | 2.03 |
| 15 | 19 1/4 x 63 1/4 | 18 1/8 x 62 | 13 3/8 x 28 | 2.60 |
| 16 | 19 1/4 x 72 1/4 | 18 1/8 x 71 | 13 3/8 x 32 4/8 | 3.02 |
| 1 x 76 3/4 | 19 1/4 x 77 | 18 1/8 x 75 3/4 | 13 3/8 x 34 7/8 | 3.24 |
| | | | | |
| 1/32 | 26 3/4 x 26 1/4 | 25 1/2 x 25 | 20 3/4 x 9 4/8 | 1.37 |
| 1/33 | 26 3/4 x 38 5/8 | 25 1/2 x 37 3/8 | 20 3/4 x 15 6/8 | 2.26 |
| 1/34 | 26 3/4 x 50 7/8 | 25 1/2 x 49 5/8 | 20 3/4 x 21 7/8 | 3.14 |
| 1/35 | 26 3/4 x 63 1/4 | 25 1/2 x 62 | 20 3/4 x 28 | 4.03 |
| 1/36 | 26 3/4 x 72 1/4 | 25 1/2 x 71 | 20 3/4 x 32 4/8 | 4.68 |
| 1/3 x 76 3/4 | 26 3/4 x 77 | 25 1/2 x 75 3/4 | 20 3/4 x 34 7/8 | 5.03 |
| | | | | |
| 22 | 37 1/4 x 26 1/4 | 36 x 25 | 31 1/4 x 9 4/8 | 2.06 |
| 23 | 37 1/4 x 38 5/8 | 36 x 37 3/8 | 31 1/4 x 15 6/8 | 3.40 |
| 24 | 37 1/4 x 50 7/8 | 36 x 49 5/8 | 31 1/4 x 21 7/8 | 4.73 |
| 39 3/8 x 58 1/8 | 39 3/8 x 58 1/8 | 38 1/8 x 56 7/8 | 33 3/8 x 25 4/8 | 5.90 |
| 25 | 37 1/4 x 63 1/4 | 36 x 62 | 31 1/4 x 28 | 6.08 |
| 26 | 37 1/4 x 72 1/4 | 36 x 71 | 31 1/4 x 32 4/8 | 7.05 |
| 2 x 76 3/4 | 37 1/4 x 77 | 36 x 75 3/4 | 31 1/4 x 34 7/8 | 7.57 |
| | | | | |
| 32 | 53 3/8 x 26 1/4 | 52 1/8 x 25 | 47 3/8 x 9 4/8 | 3.13 |
| 33 | 53 3/8 x 38 5/8 | 52 1/8 x 37 3/8 | 47 3/8 x 15 6/8 | 5.16 |
| 34 | 53 3/8 x 50 7/8 | 52 1/8 x 49 5/8 | 47 3/8 x 21 7/8 | 7.18 |
| 35 | 53 3/8 x 63 1/4 | 52 1/8 x 62 | 47 3/8 x 28 | 9.21 |
| 36 | 53 3/8 x 72 1/4 | 52 1/8 x 71 | 47 3/8 x 32 4/8 | 10.69 |

SERIES 150/160 SINGLE HUNG

Features:

- Cam Locks are standard. Double Locks are featured on all windows measuring more than 27 1/4" in width.
- Block and Tackle balances provide quiet, easy operation.
- Integrated tilt latches permit easy tilt in and cleaning.
- Sloped sill for easy water run-off.
- Pre-punched nailing fin allows for faster installation.
- Sashes are available in equal lite, Cottage and Oriel styles.
- Integrated J-channel assists in the installation of vinyl siding.
- White is standard.
- Series 160 available without J-channel.
- DP Ratings:
 - DP-50 (window size tested 36" x 74")
 - DP-35 (window size tested 36" x 96")
 - DP-25 (window size tested 48" x 96")

Custom Options:

- Low-E Glass and Argon Gas
- Ultra Low-E Argon.
- 3/4" or 5/8" flat grid, 5/8" or 1" contoured and 1 1/8" Simulated Divided Lite (SDL) grids.
- Factory mulling of twins, triples and architectural shapes.
- Almond and Clay vinyl colors.
- Nine painted exterior colors (white interior only).
- Foamed PVC jamb extensions (pre-primed or stainable 4 9/16" and 6 9/16").
- Window Opening Control Device (WOCD) for fall prevention (field applied).
- Continuous Head and Sill.

Materials:

- Frame and sash are maintenance free, color stabilized solid vinyl (PVC).
- Lift rail, lock rail, and the meeting rail contain aluminum rebar for added strength. Windows more than 60" in height also have rebar in the stiles.
- The screen is comprised of rolled form aluminum frame and fiberglass mesh.
- Glazing method: Glazing tape.

Structural Performance

| SERIES/MODEL | TEST SIZE | AIR (cfm/ft ² _) | WATER (psf) | UNIFORM LOAD | DESIGN PRESSURE |
|------------------------|-----------|-----------------------------|-------------|--------------|-----------------|
| 150/160 SH/DW | 36 X 74 | 0.27 | 7.50 | 75.00 | H-R50 36X74 |
| 150/160 SH/DW | 48 X 78 | 0.27 | 7.50 | 37.50 | H-R25 48X78 |
| 150/160 SHTW | 72 X 72 | 0.15 | 6.75 | 60.00 | H-R40 72X72 |
| 150/160 TRHP | 108 X 74 | 0.15 | 7.50 | 75.00 | H-R50 108X74 |
| 150/160 TR | 108 X 74 | 0.15 | 6.00 | 45.00 | H-R30 108X74 |
| 150/160 PW/HR/FR/OC/SS | 72 X 72 | 0.01 | 7.50 | 75.00 | F-R50 72x72 |

Thermal Performance

| Climate Zone | Low-E Surface 2 | Low-E Surface 4 | Spacer | Gas | Foam | U-Value | SHGC | | VT | | |
|----------------------|-----------------|-----------------|---|-------|---------|----------------------|------|---------|------|---------|------|
| | | | | | | | Grid | No Grid | Grid | No Grid | |
| North | 180 (DS ONLY) | i89 (DS ONLY) | Intercept Tin | Argon | Foam | DS | 0.26 | 0.45 | 0.50 | 0.55 | 0.61 |
| North Central | 270 (DS only) | i89 (DS ONLY) | Intercept Tin | Argon | Foam | DS | 0.25 | 0.26 | 0.29 | 0.48 | 0.54 |
| South Central | 366 | Clear | SS or DS - Duralite DS - Intercept Ultra | Argon | Foam | SS - Duralite | 0.28 | 0.20 | 0.22 | 0.46 | 0.52 |
| | | | | | | DS - Duralite | 0.28 | 0.20 | 0.22 | 0.46 | 0.51 |
| | | | | | | DS - Ultra | 0.28 | 0.20 | 0.22 | 0.46 | 0.51 |
| South | 366 | Clear | Intercept Tin | Argon | No Foam | SS | 0.31 | 0.20 | 0.22 | 0.46 | 0.52 |
| | | | | | | DS | 0.31 | 0.20 | 0.22 | 0.46 | 0.51 |

SERIES 150/160 SINGLE HUNG

| SERIES | 150/160 SH |
|------------------------------------|------------------------|
| VINYL WALL THICKNESS | 0.065" (1.65MM) |
| GLASS THICKNESS | 0.750" (19.05MM) |
| JAMB THICKNESS | 3.277" (83.24MM) |
| FRAME WIDTH | 2.412" (61.26MM) |
| NAILING FIN LENGTH | 1.365" (34.67MM) |
| NAIL FIN SETBACK | 1.537" (39.04MM) |
| "J" CHANNEL DEPTH | .625" (15.88MM) |
| EGRESS WIDTH | (WW) - 4 13/16" |
| EGRESS HEIGHT (WITH SASH) | (WH/2) - 3 15/16" |
| EGRESS HEIGHT (WITHOUT SASH) | (WH/2) - 3 1/8" |
| TOP SASH DAYLIGHT OPENING WIDTH | (WW) - 5 1/8" |
| BOTTOM SASH DAYLIGHT OPENING WIDTH | (WW) - 5 1/2" |
| DAYLIGHT OPENING HEIGHT | (WH/2) - 3 7/16" |
| SCREEN WIDTH | (WW) - 4 3/8" |
| SCREEN HEIGHT | (WH/2) - 1 1/4" |
| OPTIONS GLASS: | |
| CLEAR (STANDARD) | • |
| LOW-E ARGON | • |
| ULTRA LOW-E WITH ARGON | • |
| OBSCURE | • |
| TEMPERED | • |
| DOUBLE STRENGTH | • |
| OPTIONS GAS: | |
| ARGON | • |
| AVAILABLE SPECIAL SHAPES: | |
| FULL ROUNDS | QUARTER ROUNDS |
| HALF ROUNDS | ELLIPTICALS |
| OCTAGONS | PENTAGONS |
| TRAPEZOIDS | TRIANGLES |
| HALF EYEBROWS | EYEBROWS |
| COLONIAL ARCHES | COLONIAL FLANKERS |
| OVALS | COLONIAL ARCH FLANKERS |
| OPERABLE EYEBROWS | OPERABLE HALF EYEBROWS |

(WW) = WINDOW WIDTH
 (WH) = WINDOW HEIGHT

SERIES 150/160 SINGLE HUNG

Series 150 vertical diagram

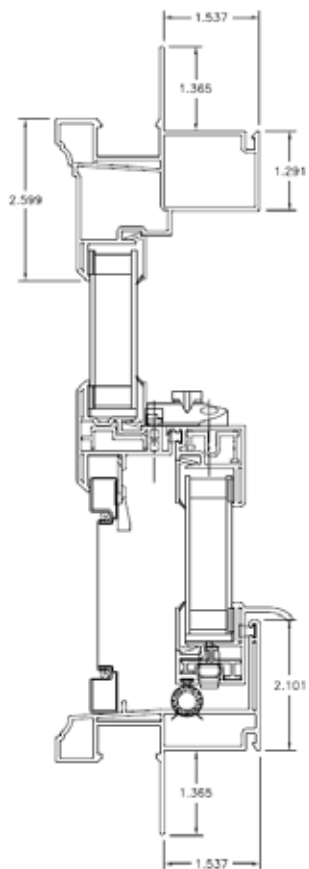

Series 160 vertical diagram

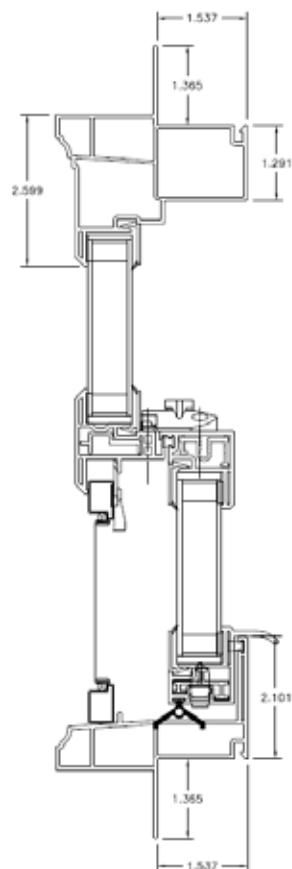

Series 150 horizontal diagram

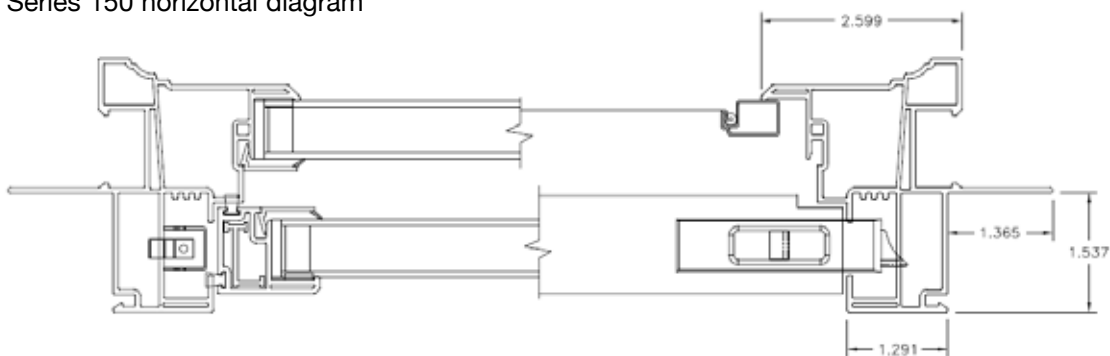

Series 160 horizontal diagram

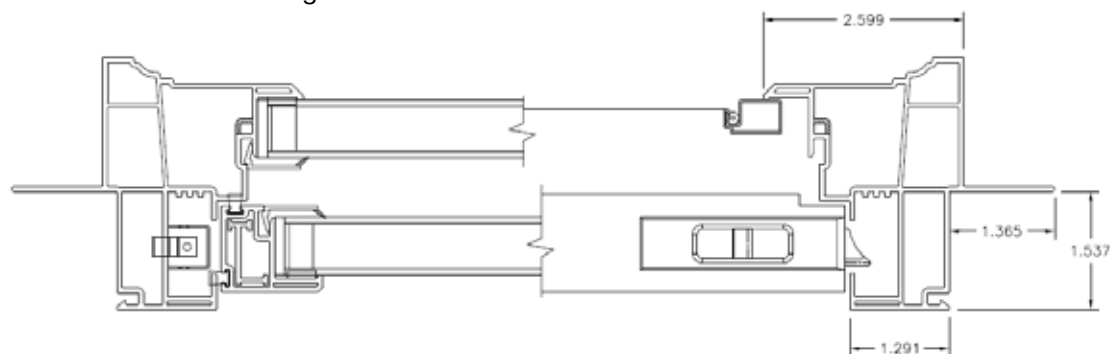

Mulled Units:

Factory mulling of twins, triples and special shapes provides easier installation without extra labor or material costs.

Reinforcement is available for added strength in factory mulled units.

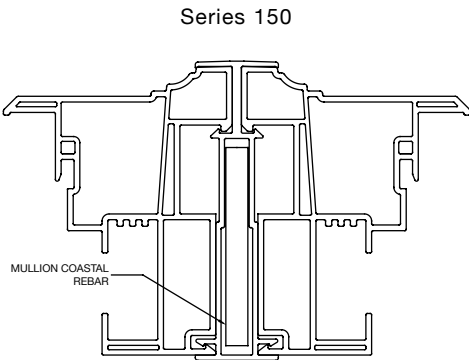

Recommended Rough Opening:

Width = Window Width (WW) + 1/2"

Height = Window Height (WH) + 1/2"

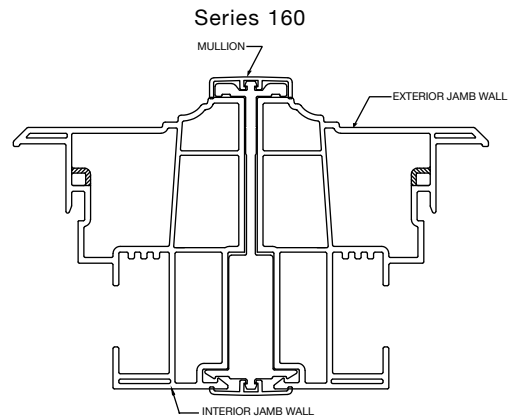

Recommended Rough Opening:

Width = Window Width (WW) + 1/2"

Height = Window Height (WH) + 1/2"

Foamed PVC Jamb Extension:

The interior foamed PVC jamb extension is available in pre-primed or stainable version for your convenience and ease of installation for a frame thickness of either 4 9/16" or 6 9/16".

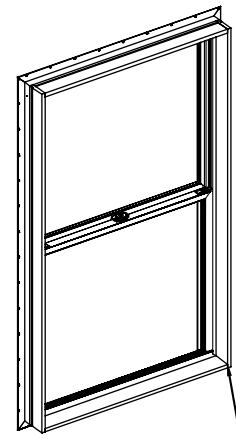

WOOD EXTENSION 3" X 5/8"
OVERALL WALL THICKNESS = 4 9/16"

SERIES 150/160 SINGLE HUNG





































































































































Series 150/160 Single Hung Size Chart

SERIES 150/160 SINGLE HUNG

*Meets egress of: Clear operable area of ≥ 5.7 sq. ft.

Clear operable width of $\geq 20"$

Clear operable height of $\geq 24"$

| ROUGH OPENING | 20" | 24" | 28" | 30" | 32" | 36" | 38" | 40" | 44" | 48" |
|---------------|---|---|--|--|--|--|--|--|--|--|
| EXACT SIZE | 19.5" | 23.5" | 27.5" | 29.5" | 31.5" | 35.5" | 37.5" | 39.5" | 43.5" | 47.5" |
| EGRESS WIDTH | 14.6875" | 18.6875" | 22.6875" | 24.6875" | 26.6875" | 30.6875" | 32.6875" | 34.6875" | 38.6875" | 42.6875" |
| HEIGHT | | | | | | | | | | |
| 36" |  1830 |  2030 |  2430 |  2630 |  2830 |  3030 |  3230 |  3430 |  3830 | |
| 38" |  1832 |  2032 |  2432 |  2632 |  2832 |  3032 |  3232 |  3432 |  3832 | |
| 44" |  1838 |  2038 |  2438 |  2638 |  2838 |  3038 |  3238 |  3438 |  3838 | |
| 46" |  18310 |  20310 |  24310 |  26310 |  28310 |  30310 |  32310 |  34310 |  38310 | |
| 48" |  1840 |  2040 |  2440 |  2640 |  2840 |  3040 |  3240 |  3440 |  3840 | |
| 50" |  1842 |  2042 |  2442 |  2642 |  2842 |  3042 |  3242 |  3442 |  3842 | |
| 52" |  1844 |  2044 |  2444 |  2644 |  2844 |  3044 |  3244 |  3444 |  3844 | |
| 54" |  1846 |  2046 |  2446 |  2646 |  2846 |  3046 |  3246 |  3446 |  3846 | |
| 60" |  1850 |  2050 |  2450 |  2650 |  2850 |  3050 |  3250* |  3450* |  3850* |  4050* |
| 62" |  1852 |  2052 |  2452 |  2652 |  2852 |  3052* |  3252* |  3452* |  3852* |  4052* |
| 66" |  1856 |  2056 |  2456 |  2656 |  2856 |  3056* |  3256* |  3456* |  3856* |  4056* |
| 72" |  1860 |  2060 |  2460 |  2660 |  2860* |  3060* |  3260* |  3460* |  3860* |  4060* |
| 74" |  1862 |  2062 |  2462 |  2662 |  2862* |  3062* |  3262* |  3462* |  3862* |  4062* |
| 84" |  1870 |  2070 |  2470* |  2670* |  2870* |  3070* |  3270* |  3470* |  3870 |  4070 |

SERIES 150/160 SINGLE HUNG

Series 150/160 Single Hung Egress Chart

**SERIES 150/160 SINGLE HUNG
DAYLIGHT OPENING AND EGRESS SQUARE FOOTAGE**

| NOM. SIZE | WINDOW TOTAL DAYLIGHT OPENING SQUARE FEET | EGRESS TOTAL SQUARE FEET (WITH SASH) | NOM. SIZE | WINDOW TOTAL DAYLIGHT OPENING SQUARE FEET | EGRESS TOTAL SQUARE FEET (WITH SASH) |
|-----------|--|---|-----------|--|---|
| 1830 | 2.82 | 1.4 | 3030 | 6.00 | 2.9 |
| 1832 | 3.02 | 1.5 | 3032 | 6.42 | 3.2 |
| 1838 | 3.61 | 1.8 | 3038 | 7.68 | 3.8 |
| 18310 | 3.81 | 1.9 | 30310 | 8.10 | 4.0 |
| 1840 | 4.00 | 2.0 | 3040 | 8.52 | 4.2 |
| 1842 | 4.20 | 2.1 | 3042 | 8.94 | 4.4 |
| 1844 | 4.40 | 2.2 | 3044 | 9.35 | 4.7 |
| 1846 | 4.59 | 2.3 | 3046 | 9.77 | 4.9 |
| 1850 | 5.18 | 2.6 | 3050 | 11.03 | 5.5 |
| 1852 | 5.38 | 2.7 | 3052 | 11.45 | 5.7 |
| 1856 | 5.78 | 2.9 | 3056 | 12.29 | 6.1 |
| 1860 | 6.37 | 3.2 | 3060 | 13.55 | 6.8 |
| 1862 | 6.56 | 3.4 | 3062 | 13.97 | 7.0 |
| 1870 | 7.55 | 3.9 | 3070 | 16.06 | 8.0 |
| 2030 | 3.62 | 1.8 | 3230 | 6.40 | 2.9 |
| 2032 | 3.87 | 1.9 | 3232 | 6.85 | 3.2 |
| 2038 | 4.63 | 2.3 | 3238 | 8.19 | 3.8 |
| 20310 | 4.88 | 2.4 | 32310 | 8.63 | 4.0 |
| 2040 | 5.13 | 2.6 | 3240 | 9.08 | 4.2 |
| 2042 | 5.38 | 2.7 | 3242 | 9.53 | 4.4 |
| 2044 | 5.64 | 2.8 | 3244 | 9.97 | 5.0 |
| 2046 | 5.89 | 3.0 | 3246 | 10.42 | 5.2 |
| 2050 | 6.65 | 3.4 | 3250 | 11.76 | 5.9 |
| 2052 | 6.90 | 3.5 | 3252 | 12.21 | 6.0 |
| 2056 | 7.40 | 3.7 | 3256 | 13.10 | 6.5 |
| 2060 | 8.16 | 4.1 | 3260 | 14.45 | 7.2 |
| 2062 | 8.41 | 4.3 | 3262 | 14.89 | 7.5 |
| 2070 | 9.68 | 4.9 | 3270 | 17.13 | 8.6 |
| 2430 | 4.41 | 2.2 | 3430 | 6.80 | 3.3 |
| 2432 | 4.72 | 2.3 | 3432 | 7.27 | 3.6 |
| 2438 | 5.64 | 2.8 | 3438 | 8.70 | 4.3 |
| 24310 | 5.95 | 3.0 | 34310 | 9.17 | 4.5 |
| 2440 | 6.26 | 3.1 | 3440 | 9.64 | 4.8 |
| 2442 | 6.57 | 3.3 | 3442 | 10.12 | 5.0 |
| 2444 | 6.88 | 3.4 | 3444 | 10.59 | 5.3 |
| 2446 | 7.18 | 3.6 | 3446 | 11.07 | 5.5 |
| 2450 | 8.11 | 4.0 | 3450 | 12.49 | 6.2 |
| 2452 | 8.42 | 4.2 | 3452 | 12.97 | 6.5 |
| 2456 | 9.03 | 4.5 | 3456 | 13.92 | 6.9 |
| 2460 | 9.96 | 5.0 | 3460 | 15.34 | 7.7 |
| 2462 | 10.27 | 5.2 | 3462 | 15.82 | 7.9 |
| 2470 | 11.81 | 6.0 | 3470 | 18.19 | 9.1 |
| 2630 | 4.81 | 2.4 | 3830 | 7.59 | 3.7 |
| 2632 | 5.14 | 2.5 | 3832 | 8.12 | 4.0 |
| 2638 | 6.15 | 3.1 | 3838 | 9.71 | 4.8 |
| 26310 | 6.49 | 3.2 | 38310 | 10.24 | 5.0 |
| 2640 | 6.82 | 3.4 | 3840 | 10.77 | 5.3 |
| 2642 | 7.16 | 3.6 | 3842 | 11.30 | 5.6 |
| 2644 | 7.50 | 3.7 | 3844 | 11.83 | 5.9 |
| 2646 | 7.83 | 3.9 | 3846 | 12.36 | 6.1 |
| 2650 | 8.84 | 4.4 | 3850 | 13.96 | 6.9 |
| 2652 | 9.18 | 4.6 | 3852 | 14.49 | 7.2 |
| 2656 | 9.85 | 4.9 | 3856 | 15.55 | 7.7 |
| 2660 | 10.85 | 5.5 | 3860 | 17.14 | 8.6 |
| 2662 | 11.19 | 5.6 | 3862 | 17.67 | 8.8 |
| 2670 | 12.87 | 6.5 | 3870 | 20.32 | 10.2 |
| 2830 | 5.21 | 2.6 | 4050 | 15.42 | 7.7 |
| 2832 | 5.57 | 2.8 | 4052 | 16.00 | 8.0 |
| 2838 | 6.66 | 3.3 | 4056 | 17.18 | 8.5 |
| 28310 | 7.02 | 3.5 | 4060 | 18.93 | 9.4 |
| 2840 | 7.39 | 3.7 | 4062 | 19.52 | 9.7 |
| 2842 | 7.75 | 3.9 | 4070 | 22.45 | 11.2 |
| 2844 | 8.12 | 4.0 | | | |
| 2846 | 8.48 | 4.2 | | | |
| 2850 | 9.57 | 4.8 | | | |
| 2852 | 9.93 | 5.0 | | | |
| 2856 | 10.66 | 5.3 | | | |
| 2860 | 11.75 | 5.9 | | | |
| 2862 | 12.12 | 6.1 | | | |
| 2870 | 13.93 | 7.0 | | | |

SERIES 450/460 DOUBLE HUNG

Features:

- Brick mould exterior.
- Maintenance-free, premium vinyl construction.
- Fusion-welded frame and sash.
- Integrated J-channel and prepunched nailing fin.
- 3/4" insulated glass.
- Sloped sill for easy water run-off.
- Double sash locks standard at 27 1/4" and wider.
- Continuous head and sill for twins and triples.
- Block and Tackle balance system.
- Extruded Half Screen standard.
- White is standard.
- Series 460 available without J-Channel.
- DP Ratings:
R-50 (window size tested 36" x 74")
R-30 (window size tested 48" x 78")

Custom Options:

- Low-E Glass and Argon Gas.
- Ultra Low-E Argon.
- 5/8" or 1" contoured, 5/8" or 3/4" flat grid or 1 1/8" Simulated Divided Lite.
- Factory mulling of twins, triples and architectural shapes.
- Foamed PVC jamb extensions (pre-primed or stainable 4 9/16" and 6 9/16").
- Custom sizes available.
- Almond and Clay vinyl colors.
- Nine painted exterior colors (white interior only).
- 3 1/4" Flat Casing with Bull Nose.
- Window Opening Control Device (WOCD) for fall prevention (factory applied).
- Extruded Full Screen.

Materials:

- Frame and sash are maintenance free, color stabilized solid vinyl (PVC).
- Keeper rail, lock rail and bottom lift rail contain an aluminum rebar for added strength.
- The screen is comprised of a roll form aluminum frame and fiberglass mesh.
- Glazing method: Glazing tape.

Structural Performance

| SERIES/MODEL | TEST SIZE | AIR (cfm/ft ₂) | WATER (psf) | UNIFORM LOAD | DESIGN PRESSURE |
|------------------------------------|-----------|----------------------------|-------------|--------------|-----------------|
| 450/460 DH | 36 x 74 | 0.26 | 5.43 | 52.63 | H-R35 36x74 |
| 450/460 DH | 48 x 78 | 0.26 | 5.43 | 30.08 | H-R20 48x78 |
| 450/460 DHTR (cont. head & sill) | 108 x 74 | 0.16 | 7.52 | 52.67 | H-R25 108x74 |
| 455/465 DH HP | 36 x 74 | 0.26 | 7.52 | 75.19 | H-R50 36x74 |
| 455/465 DHTRCHS | 108 x 74 | 0.16 | 7.52 | 75.19 | H-R50 108x74 |
| 450/460 and 455/465 PW/HR/FR/OC/SS | 50 x 86 | 0.01 | 7.52 | 75.24 | F-R50 50x86 |

Thermal Performance

| Climate Zone | Low-E Surface 2 | Low-E Surface 4 | Spacer | Gas | Foam | DS | U-Value | SHGC | | VT | |
|----------------------|-----------------|-----------------|---------------|-------|---------|-----------|---------|------|---------|------|---------|
| | | | | | | | | Grid | No Grid | Grid | No Grid |
| North | 180 (DS ONLY) | i89 (DS ONLY) | Duralite | Argon | No Foam | DS | 0.26 | 0.41 | 0.46 | 0.50 | 0.56 |
| North Central | 366 (DS ONLY) | i89 (DS ONLY) | Duralite | Argon | No Foam | DS | 0.25 | 0.18 | 0.20 | 0.41 | 0.46 |
| South Central | 366 | Clear | Duralite | Argon | Foam | SS | 0.28 | 0.18 | 0.20 | 0.42 | 0.48 |
| | | | | | | DS | 0.28 | 0.18 | 0.20 | 0.42 | 0.47 |
| South | 366 | Clear | Intercept Tin | Argon | No Foam | SS | 0.30 | 0.18 | 0.20 | 0.42 | 0.48 |
| | | | | | | DS | 0.30 | 0.18 | 0.20 | 0.42 | 0.47 |

SERIES 450/460 DOUBLE HUNG

| SERIES | 450/460 DH |
|----------------------------------|---|
| VINYL WALL THICKNESS: FRAME/SASH | SASH = 0.070" (1.78MM) FRAME = 0.065" (1.65MM) |
| GLASS THICKNESS | 0.750" (19.05MM) |
| JAMB THICKNESS | 3.868" (98.25MM) |
| FRAME WIDTH | 2.563" (65.10MM) |
| NAILING FIN LENGTH | 1.365" (34.67MM) |
| NAIL FIN SETBACK | 2.185" (55.50MM) |
| "J" CHANNEL DEPTH | .750" (19.05MM) |
| EGRESS WIDTH | (WW) - 4 3/4" |
| EGRESS HEIGHT (WITH SASH) | (WH/2) - 5 9/16" |
| EGRESS HEIGHT (WITHOUT SASH) | (WH/2) - 2 1/2" |
| SASH DAYLIGHT OPENING WIDTH | (WW) - 6 3/4" |
| DAYLIGHT OPENING HEIGHT | (WH/2) - 4 1/8" |
| SCREEN WIDTH | (WW) - 4 7/16" |
| SCREEN HEIGHT (HALF) | (WH/2) |
| SCREEN HEIGHT (FULL) | (WH) - 3 5/16" |
| OPTIONS GLASS: | |
| CLEAR (STANDARD) | • |
| LOW-E WITH ARGON | • |
| ULTRA LOW-E WITH ARGON | • |
| OBSCURE | • |
| TEMPERED | • |
| DOUBLE STRENGTH | • |
| OPTIONS GAS: | |
| ARGON | • |
| AVAILABLE SPECIAL SHAPES: | |
| FULL ROUNDS | QUARTER ROUNDS |
| HALF ROUNDS | ELLIPTICALS |
| OCTAGONS | PENTAGONS |
| TRAPEZOIDS | TRIANGLES |
| HALF EYEBROWS | EYEBROWS |
| COLONIAL ARCHES | COLONIAL FLANKERS |
| | COLONIAL ARCH FLANKERS |

(WW) = WINDOW WIDTH
(WH) = WINDOW HEIGHT

SERIES 450/460 DOUBLE HUNG

Series 450 vertical diagram

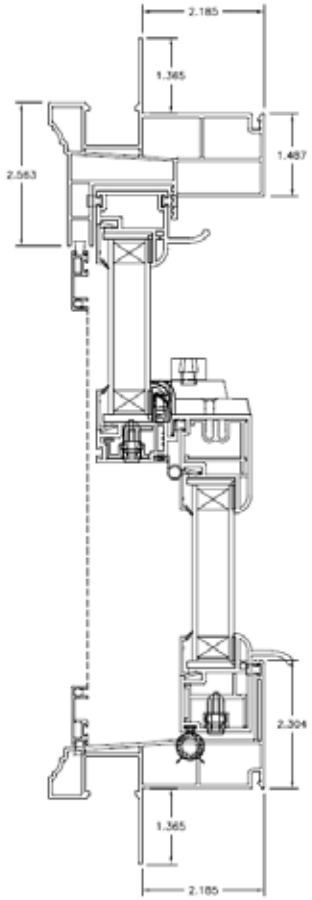

Series 460 vertical diagram

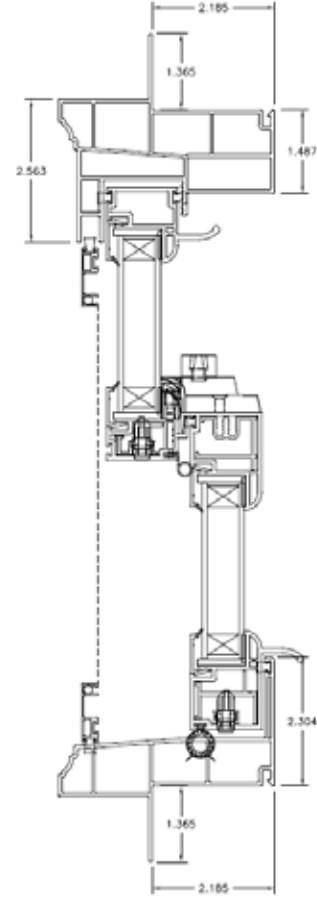

Series 450 horizontal diagram

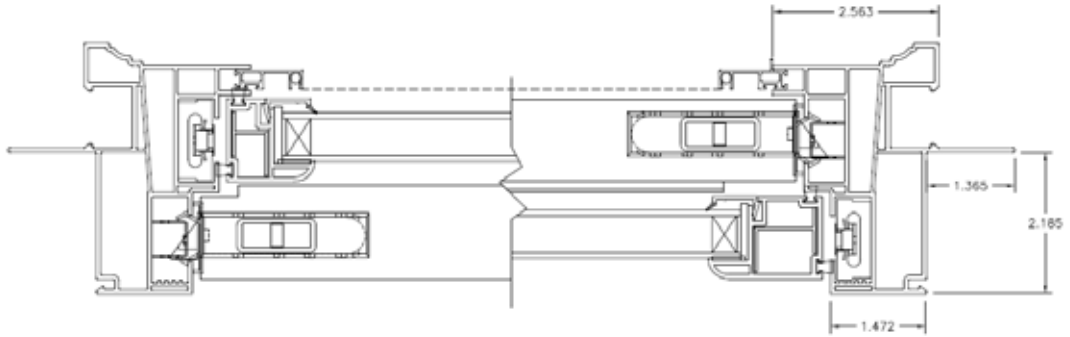

Series 460 horizontal diagram

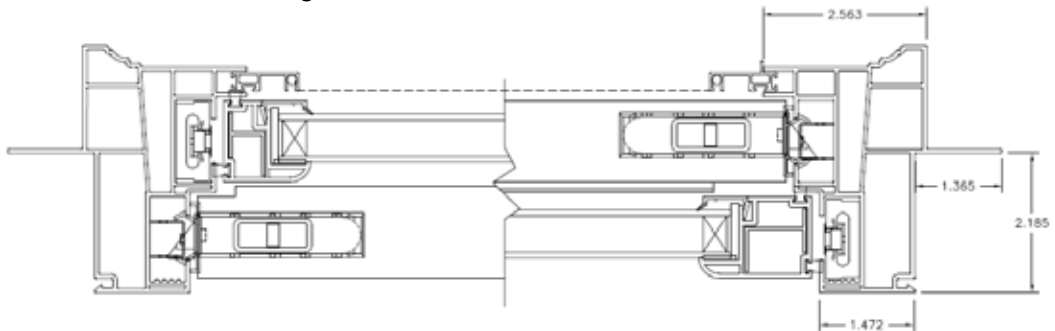

Mulled Units:

Factory mulling of twins, triples and special shapes provides easier installation without extra labor or material costs.

Steel reinforcement is offered as an option to meet higher wind load requirements.

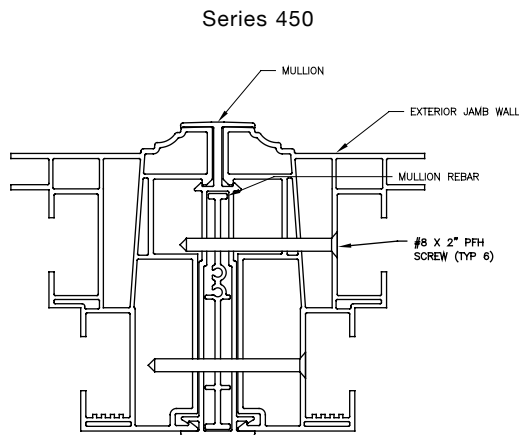

Recommended Rough Opening:

Width = Window Width (WW) + 1/2"

Height = Window Height (WH) + 1/2"

Foamed PVC Jamb Extension:

The interior foamed PVC jamb extension is available in pre-primed or stainable version for your convenience and ease of installation for a frame thickness of either 4 9/16" or 6 9/16".

Series 450/460

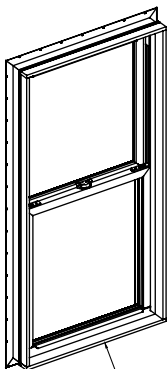

WOOD EXTENSION 2 3/8" X 5/8"
OVERALL WALL THICKNESS = 4 9/16"

Series 450/460 Twin

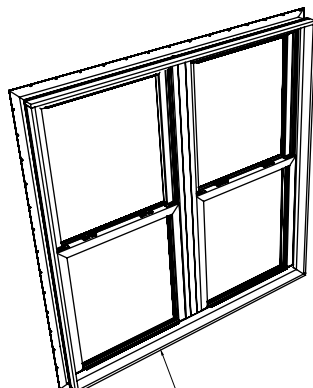

WOOD EXTENSION 2 3/8" X 5/8"
OVERALL WALL THICKNESS = 4 9/16"

Series 450/460 Triple

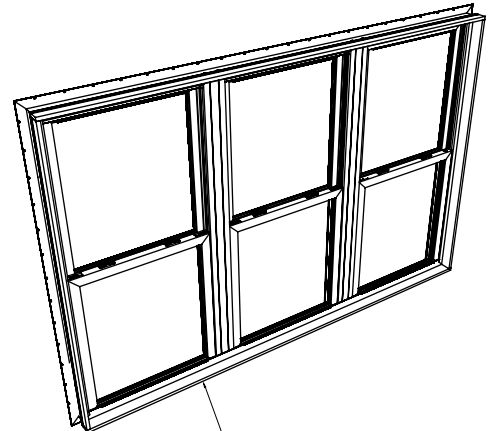

WOOD EXTENSION 2 3/8" X 5/8"
OVERALL WALL THICKNESS = 4 9/16"

SERIES 450/460 DOUBLE HUNG

Series 450/460 Double Hung Size Chart

SERIES 450/460 DOUBLE HUNG

*Meets egress of: Clear operable area of ≥ 5.7 sq. ft.

Clear operable width of $\geq 20"$

Clear operable height of $\geq 24"$

| ROUGH OPENING | 20" | 24" | 28" | 30" | 32" | 36" | 38" | 40" | 44" | 48" |
|---------------|--------|--------|--------|--------|--------|--------|--------|--------|--------|--------|
| EXACT SIZE | 19.5" | 23.5" | 27.5" | 29.5" | 31.5" | 35.5" | 37.5" | 39.5" | 43.5" | 47.5" |
| EGRESS WIDTH | 14.75" | 18.75" | 22.75" | 24.75" | 26.75" | 30.75" | 32.75" | 34.75" | 38.75" | 42.75" |
| HEIGHT | | | | | | | | | | |
| 36" | 1830 | 2030 | 2430 | 2630 | 2830 | 3030 | | | | |
| 38" | 1832 | 2032 | 2432 | 2632 | 2832 | 3032 | | | | |
| 44" | 1838 | 2038 | 2438 | 2638 | 2838 | 3038 | | | | |
| 46" | 18310 | 20310 | 24310 | 26310 | 28310 | 30310 | | | | |
| 48" | 1840 | 2040 | 2440 | 2640 | 2840 | 3040 | 3240 | | | |
| 50" | 1842 | 2042 | 2442 | 2642 | 2842 | 3042 | 3242 | | | |
| 52" | 1844 | 2044 | 2444 | 2644 | 2844 | 3044 | 3244 | | | |
| 54" | 1846 | 2046 | 2446 | 2646 | 2846 | 3046 | 3246 | | | |
| 60" | 1850 | 2050 | 2450 | 2650 | 2850 | 3050 | 3250 | 3450* | 3850* | 4050* |
| 62" | 1852 | 2052 | 2452 | 2652 | 2852 | 3052 | 3252* | 3452* | 3852* | 4052* |
| 66" | 1856 | 2056 | 2456 | 2656 | 2856 | 3056* | 3256* | 3456* | 3856* | 4056* |
| 72" | 1860 | 2060 | 2460 | 2660 | 2860 | 3060* | 3260* | 3460* | 3860* | 4060* |
| 74" | 1862 | 2062 | 2462 | 2662 | 2862* | 3062* | 3262* | 3462* | 3862* | 4062* |

SERIES 450/460 DOUBLE HUNG

Series 450/460 Double Hung Egress Chart

SERIES 450/460 DOUBLE HUNG DAYLIGHT OPENING SIZE CHART

| NOM. SIZE | WINDOW TOTAL DAYLIGHT OPENING SQUARE FEET | EGRESS TOTAL SQUARE FEET (WITH SASH) | NOM. SIZE | WINDOW TOTAL DAYLIGHT OPENING SQUARE FEET | EGRESS TOTAL SQUARE FEET (WITH SASH) |
|-----------|--|---|-----------|--|---|
| 1830 | 2.41 | 1.3 | 2830 | 4.68 | 2.3 |
| 1832 | 2.59 | 1.4 | 2832 | 5.03 | 2.5 |
| 1838 | 3.12 | 1.7 | 2838 | 6.06 | 3.0 |
| 18310 | 3.30 | 1.8 | 28310 | 6.40 | 3.2 |
| 1840 | 3.48 | 1.9 | 2840 | 6.75 | 3.4 |
| 1842 | 3.65 | 2.0 | 2842 | 7.09 | 3.6 |
| 1844 | 3.83 | 2.1 | 2844 | 7.43 | 3.8 |
| 1846 | 4.01 | 2.2 | 2846 | 7.78 | 3.9 |
| 1850 | 4.54 | 2.5 | 2850 | 8.81 | 4.5 |
| 1852 | 4.71 | 2.6 | 2852 | 9.15 | 4.7 |
| 1856 | 5.07 | 2.8 | 2856 | 9.84 | 5.1 |
| 1860 | 5.60 | 3.1 | 2860 | 10.87 | 5.6 |
| 1862 | 5.78 | 3.2 | 2862 | 11.21 | 5.8 |
| 2030 | 3.17 | 1.6 | 3030 | 5.44 | 2.6 |
| 2032 | 3.40 | 1.7 | 3032 | 5.84 | 2.8 |
| 2038 | 4.10 | 2.1 | 3038 | 7.04 | 3.5 |
| 20310 | 4.33 | 2.2 | 30310 | 7.44 | 3.7 |
| 2040 | 4.57 | 2.4 | 3040 | 7.84 | 3.9 |
| 2042 | 4.80 | 2.5 | 3042 | 8.24 | 4.1 |
| 2044 | 5.03 | 2.6 | 3044 | 8.63 | 4.3 |
| 2046 | 5.26 | 2.8 | 3046 | 9.03 | 4.5 |
| 2050 | 5.96 | 3.2 | 3050 | 10.23 | 5.2 |
| 2052 | 6.19 | 3.3 | 3052 | 10.63 | 5.4 |
| 2056 | 6.66 | 3.5 | 3056 | 11.43 | 5.8 |
| 2060 | 7.36 | 3.9 | 3060 | 12.63 | 6.5 |
| 2062 | 7.59 | 4.1 | 3062 | 13.03 | 6.7 |
| 2430 | 3.93 | 1.9 | 3240 | 8.38 | 4.1 |
| 2432 | 4.21 | 2.1 | 3242 | 8.81 | 4.4 |
| 2438 | 5.08 | 2.6 | 3244 | 9.24 | 4.6 |
| 24310 | 5.37 | 2.7 | 3246 | 9.66 | 4.8 |
| 2440 | 5.66 | 2.9 | 3250 | 10.94 | 5.5 |
| 2442 | 5.94 | 3.0 | 3252 | 11.37 | 5.7 |
| 2444 | 6.23 | 3.2 | 3256 | 12.23 | 6.2 |
| 2446 | 6.52 | 3.4 | 3260 | 13.51 | 6.9 |
| 2450 | 7.38 | 3.8 | 3262 | 13.93 | 7.1 |
| 2452 | 7.67 | 4.0 | 3450 | 11.66 | 5.8 |
| 2456 | 8.25 | 4.3 | 3452 | 12.11 | 6.1 |
| 2460 | 9.11 | 4.8 | 3456 | 13.02 | 6.6 |
| 2462 | 9.40 | 4.9 | 3460 | 14.38 | 7.3 |
| 2630 | 4.31 | 2.1 | 3462 | 14.84 | 7.5 |
| 2632 | 4.62 | 2.3 | 3850 | 13.08 | 6.5 |
| 2638 | 5.57 | 2.8 | 3852 | 13.59 | 6.8 |
| 26310 | 5.88 | 3.0 | 3856 | 14.61 | 7.3 |
| 2640 | 6.20 | 3.1 | 3860 | 16.14 | 8.1 |
| 2642 | 6.52 | 3.3 | 3862 | 16.65 | 8.4 |
| 2644 | 6.83 | 3.5 | 4050 | 14.17 | 7.2 |
| 2646 | 7.15 | 3.6 | 4052 | 14.72 | 7.5 |
| 2650 | 8.10 | 4.2 | 4056 | 15.83 | 8.1 |
| 2652 | 8.41 | 4.3 | 4060 | 17.49 | 9.0 |
| 2656 | 9.04 | 4.7 | 4062 | 18.46 | 9.3 |
| 2660 | | 5.2 | | | |
| 2662 | 10.31 | 5.4 | | | |

HORIZONTAL SLIDERS

| SERIES | 105 2SL/3SL | 130 2SL/3SL | 151/161 2SL | 451/461 2SL/3SL |
|----------------------------------|---|---|-------------------|---|
| VINYL WALL THICKNESS | 0.062" | 0.060" | 0.065" | 0.065" |
| GLASS THICKNESS | 0.750" | 0.750" | 0.750" | 0.750" |
| JAMB THICKNESS | 2.625" | 3" | 3.277" | 3.868" |
| FRAME WIDTH | 1.312" | 2.485" | 2.416" | 2.865" |
| NAILING FIN LENGTH | 1.114" | 1.500" | 1.365" | 1.365" |
| NAIL FIN SETBACK | 1.375" | 1.9375" | 1.537" | 2.185" |
| "J" CHANNEL DEPTH | N/A | N/A | .625" | .75" |
| SCREEN WIDTH | (WW/2) - .5625" (WW/3) - .6825" (1/3, 1/3, 1/3) (WW/4) - .6875" (1/4, 1/2, 1/4) | (WW/2) - 3.00" (WW/3) - 2.5625" (1/3, 1/3, 1/3) (WW/4) - 3.125" (1/4, 1/2, 1/4) | (WW/2) - 2 11/16" | (WW/2) - 2 1/8" (1/3, 1/3, 1/3) (WW*.3333) - 1 1/2" (1/4, 1/2, 1/4) (WW/4) - 1 3/8" |
| SCREEN HEIGHT | (WH) - 1.4375" | (WH) - 3.875" | (WH) - 3 7/8" | (WH) - 4 1/4" |
| OPTIONS GLASS: | | | | |
| CLEAR (STANDARD) | • | • | • | • |
| LOW-E | • | • | • | • |
| DOUBLE STRENGTH | • | • | • | • |
| LOW-E WITH ARGON | • | • | • | • |
| ULTRA LOW-E WITH ARGON | • | • | • | • |
| TEMPERED | • | • | • | • |
| OBSCURE | • | • | • | • |
| OPTIONS GAS: | | | | |
| ARGON | • | • | • | • |
| AVAILABLE SPECIAL SHAPES: | | | | |
| FULL ROUNDS | QUARTER ROUNDS | | | |
| HALF ROUNDS | ELLIPTICALS | | | |
| OCTAGONS | PENTAGONS | | | |
| TRAPEZOIDS | TRIANGLES | | | |
| HALF EYEBROWS | EYEBROWS | | | |
| COLONIAL ARCHES | COLONIAL FLANKERS | | | |
| OVALS | COLONIAL ARCH FLANKERS | | | |

(WW) = WINDOW WIDTH
(WH) = WINDOW HEIGHT

Structural Performance

| SERIES/MODEL | TEST SIZE | AIR (cfm/ft ₂) | WATER (psf) | UNIFORM LOAD | DESIGN PRESSURE |
|--------------|-----------|----------------------------|-------------|--------------|-----------------|
| 105 2SL | 72 x 72 | 0.17 | 3.76 | | HS-R20 72x72 |
| 130 2SL | 74 x 63 | 0.10 | 7.52 | | HS-LC40 74x63 |
| 151/161 2SL | 74 X 48 | 0.09 | 4.50 | 45.00 | HS-R30 72x48 |
| 451/461 2SL | 70 X 49 | 0.14 | 3.75 | 37.50 | HS-R25 70x49 |
| 105 3SL | 96 x 60 | 0.06 | 2.92 | | HS-R20 96X60 |
| 130 3SL | 108 X 63 | 0.08 | 7.52 | | HS-R30 108X63 |
| 151/161 3SL | 108 X 60 | 0.09 | 3.00 | 30.00 | HS-R25 108x48 |

Features:

- 1 1/4" Nail-fin setback for brick veneer construction and select stucco applications.
- Sweep lock helps provide a weather-tight seal and added security.
- Versatile half screen* installs easily from inside.
- Multi-chambered vinyl lineals improve thermal performance and enhance sound absorbency.
- Fusion-welded frame and sash minimizes water and air infiltration and enhances overall durability.
- Metal reinforced meeting rail and sash rail provide added durability and enhanced security.
- Limited lifetime warranty provides reassuring peace of mind.
- Pre-punched integral nail-fin targets proper nail location for quick, easy installation.
- Tandem wheel and axle roller assemblies ensure smooth, easy operation on even the largest sizes.
- DP Ratings:
 - R-25 (window size tested 72" x 48")
 - R-20 (window size tested 72" x 72")
 - R-20 (window size tested 96" x 60") (XOX)
- Jamb depth: 2.625".

Custom Options:

- Low-E Glass.
- Low-E Glass with Argon Gas.
- Ultra Low-E Glass with Argon Gas.
- Almond vinyl color.
- 5/8" or 3/4" flat, 5/8" or 1" contoured, 5/8" contoured valance grids available.
- Custom sizes available.
- Paintable or stainable foamed PVC jamb extensions (4 9/16" and 6 9/16").

Materials:

- Frame is maintenance free, color stabilized solid vinyl (PVC).
- The screen is comprised of roll formed aluminum frame and fiberglass mesh.
- Glazing method: Glazing tape.

Mulled Units:

Factory mulling over a slider provides easier installation without extra labor or material costs.

Aluminum reinforcement is standard in factory mulled units.

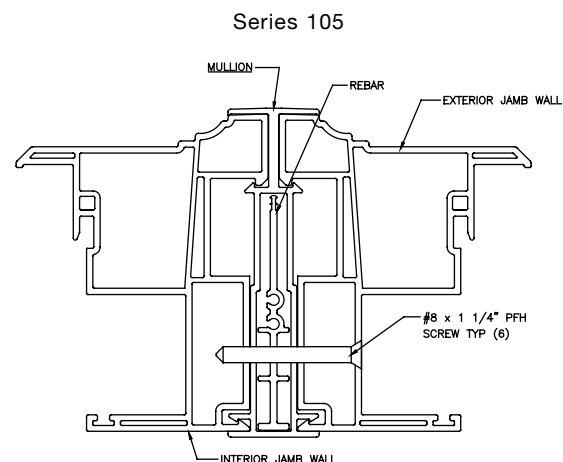

Recommended Rough Opening:

Width = Window Width (WW) + 1/2"

Height = Window Height (WH) + 1/2"

Series 105 HS vertical diagram

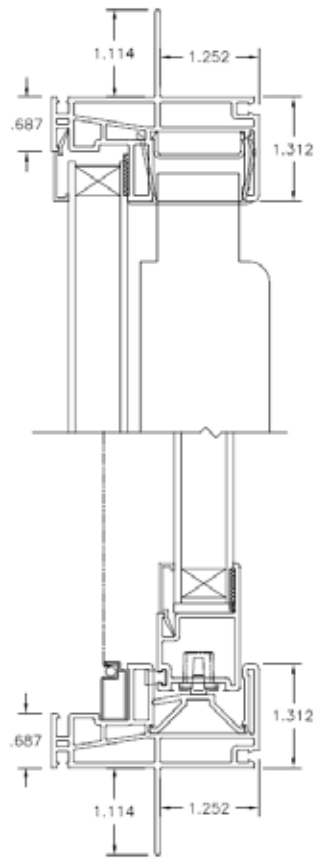

Series 105 2-Lite horizontal diagram

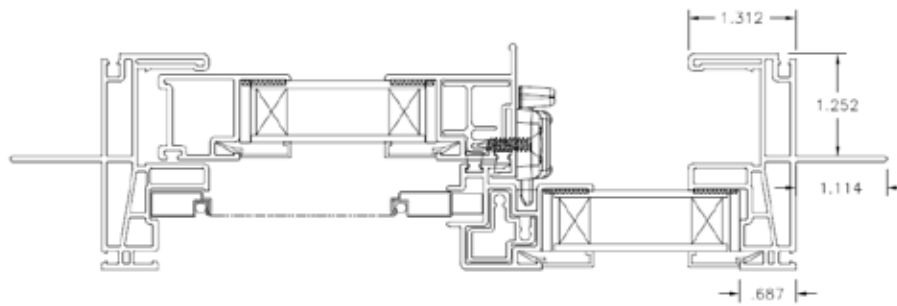

Series 105 3-Lite horizontal diagram

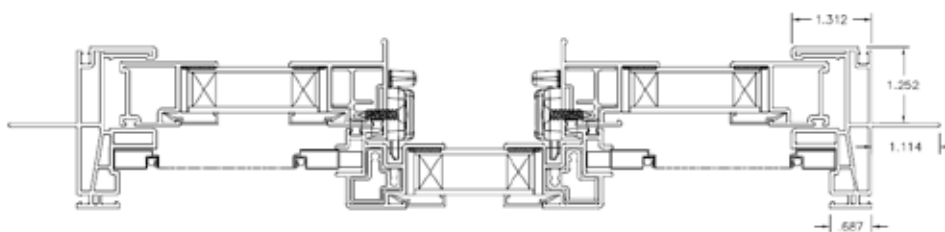

Features:

- DP-50 RATING (window size tested 74" x 50" for 2-Lite and 108" x 50" for 3-Lite).
- DP-40 Rating (window size tested 74" x 63" 2-Lite).
- DP-30 Rating (window size tested 108" x 63" 3-Lite).
- Step sill design combines water run-off and aesthetic features of a sloped sill with the structural strength and internal drainage system of a pocket sill.
- Tandem rollers ride easily along friction free channel.
- Aluminum half screen comes standard.*
- Integrated glide rail for easy sash opening and closing.
- Warm-Edge spacer system provides energy saving thermal performance.
- Aluminum reinforcement standard in lock & meeting rails.
- Dual Sweep locks (standard at 27 1/4" and above) help provide a weather-tight seal and added security.
- Dual weather-stripping helps block air and water infiltration, keeping harsh elements outside and energy-saving comfort inside.
- Jamb depth: 3".
- Limited lifetime warranty.
- DP Ratings:
 - R-50 (window size tested 74" x 50")
 - R-40 (window size tested 74" x 63")
 - R-30 (window size tested 108" x 63") (XOX)

Select from four frame types:

- Front Flange Only
- Nail Fin Only (no J-Channel)
- J-Channel (nail fin & front flange)
- Box Frame (no nail fin & no front flange)

Custom Options:

- Low-E Glass.
- Low-E Glass with Argon Gas.
- Ultra Low-E Glass with Argon Gas.
- 5/8" or 3/4" flat, 5/8" or 1" contoured and 1 1/8" Simulated Divide Lite (SDL) available.
- Almond and Clay vinyl colors.
- Bronze and Black exterior laminate (white interior only).
- Nine painted exterior colors (white interior only).
- Non-reflective Low-E Glass and Non-reflective Low-E Glass with Argon Gas.
- Double strength and obscure glass.
- Commodity sizing available.
- Custom sizes available.
- Charcoal Aluminum half screen.

Materials:

- Frame is maintenance free, color stabilized solid vinyl (PVC).
- The screen is comprised of rolled form aluminum frame and fiberglass mesh.

Mulled Units:

Series 130

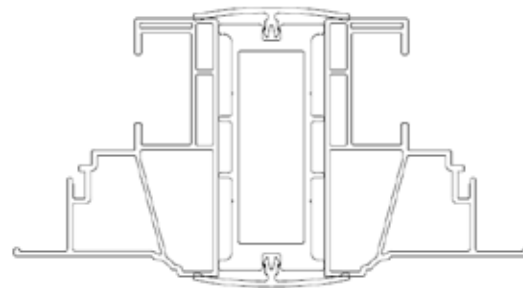

Recommended Rough Opening for Wood Frame Openings:

Width = Window Width (WW) + 1/2"

Height = Window Height (WH) + 1/2"

SERIES 130 SLIDERS

130 2-Lite Sliders Egress Charts

SERIES 130 2-LITE SLIDER EGRESS CHART

| ROUGH OPENING | 24" | 36" | 40" | 48" | 60" | 72" |
|---------------|-------|-------|-------|-------|-------|-------|
| EXACT SIZE | 23.5" | 35.5" | 39.5" | 47.5" | 59.5" | 71.5" |
| EGRESS WIDTH | 8" | 14" | 16" | 20" | 26" | 32" |
| HEIGHT | 24" | 3020 | 3420 | 4020 | 5020 | 6020 |
| | 23.5" | 2020 | 3020 | 3420 | 4020 | 5020 |
| | 18.5" | 2030 | 3030 | 3430 | 4030 | 5030 |
| | 36" | 2030 | 3030 | 3430 | 4030 | 5030 |
| 35.5" | 2040 | 3040 | 3440 | 4040 | 5040 | |
| 30.5" | 2040 | 3040 | 3440 | 4040 | 5040 | |
| 48" | 2040 | 3040 | 3440 | 4040 | 5040 | |
| 47.5" | 2040 | 3040 | 3440 | 4040 | 5040 | |
| 42.5" | 2040 | 3040 | 3440 | 4040 | 5040 | |
| 60" | 2040 | 3040 | 3440 | 4040 | 5040 | |
| 59.5" | 3050 | 3450 | 4050 | 5050 | 6050 | |
| 54.5" | 3050 | 3450 | 4050 | 5050 | 6050 | |

SERIES 130 2-LITE SLIDER EGRESS CHART

| NOM. SIZE | EGRESS WITH SASH |
|-----------|------------------|
| 2020 | 1.03 |
| 2030 | 1.67 |
| 2040 | 2.36 |
| 3020 | 3.03 |
| 3030 | 1.80 |
| 3040 | 2.97 |
| 3050 | 4.13 |
| 3420 | 2.06 |
| 3430 | 3.39 |
| 3440 | 4.72 |
| 3450 | 6.06 |
| 4020 | 2.57 |
| 4030 | 4.24 |
| 4040 | 5.90 |
| 4050 | 7.57 |
| 5020 | 3.34 |
| 5030 | 5.51 |
| 5040 | 7.67 |
| 5050 | 9.89 |
| 6020 | 4.11 |
| 6030 | 6.78 |
| 6040 | 9.44 |
| 6050 | 12.11 |

SERIES 130 2-LITE SLIDER COMMODITY EGRESS CHART

| Commodity Size | Tip to Tip Size | Exact Size | With Sash | Sq. Feet |
|----------------|-----------------|-----------------|-----------------|----------|
| 22 | 37 1/4 x 26 1/4 | 36 x 25 | 14 1/4 x 20 | 1.98 |
| 23 | 37 1/4 x 38 5/8 | 36 x 37 3/8 | 14 1/4 x 32 3/8 | 3.20 |
| 24 | 37 1/4 x 50 7/8 | 36 x 49 5/8 | 14 1/4 x 44 5/8 | 4.42 |
| DB22 | 74 1/4 x 26 1/4 | 73 x 25 | 32 3/4 x 20 | 4.55 |
| DB23 | 74 1/4 x 38 5/8 | 73 x 37 3/8 | 32 3/4 x 32 3/8 | 7.36 |
| DB24 | 74 1/4 x 50 7/8 | 73 x 49 5/8 | 32 3/4 x 44 5/8 | 10.15 |
| 32 | 53 3/8 x 26 1/4 | 52 1/8 x 25 | 22 1/3 x 20 | 3.10 |
| 33 | 53 3/8 x 38 5/8 | 52 1/8 x 37 3/8 | 22 1/3 x 32 3/8 | 5.02 |
| 34 | 53 3/8 x 50 7/8 | 52 1/8 x 49 5/8 | 22 1/3 x 44 5/8 | 6.91 |
| 1/32 | 26 3/4 x 26 1/4 | 25 1/2 x 25 | 9 x 20 | 1.25 |
| 1/33 | 26 3/4 x 38 5/8 | 25 1/2 x 37 3/8 | 9 x 32 3/8 | 2.02 |
| 1/34 | 26 3/4 x 50 7/8 | 25 1/2 x 49 5/8 | 9 x 44 5/8 | 2.79 |
| 3121 | 37 1/4 x 25 1/4 | 36 x 24 | 14 1/4 x 19 | 1.88 |
| 3131 | 37 1/4 x 37 1/4 | 36 x 36 | 14 1/4 x 31 | 3.07 |
| 3141 | 37 1/4 x 49 1/4 | 36 x 48 | 14 1/4 x 43 | 4.26 |
| 4121 | 49 1/4 x 25 1/4 | 48 x 24 | 20 1/4 x 19 | 2.67 |
| 4131 | 49 1/4 x 37 1/4 | 48 x 36 | 20 1/4 x 31 | 4.36 |
| 4141 | 49 1/4 x 49 1/4 | 48 x 48 | 20 1/4 x 43 | 6.05 |
| 5121 | 61 1/4 x 25 1/4 | 60 x 24 | 26 1/4 x 19 | 3.46 |
| 5131 | 61 1/4 x 37 1/4 | 60 x 36 | 26 1/4 x 31 | 5.65 |
| 5141 | 61 1/4 x 49 1/4 | 60 x 48 | 26 1/4 x 43 | 7.84 |
| 6121 | 73 1/4 x 25 1/4 | 72 x 24 | 32 1/4 x 19 | 4.26 |
| 6131 | 73 1/4 x 37 1/4 | 72 x 36 | 32 1/4 x 31 | 6.94 |
| 6141 | 73 1/4 x 49 1/4 | 72 x 48 | 32 1/4 x 43 | 9.63 |

SERIES 130 SLIDERS

130 2-Lite Sliders Commodity Sizes Charts

SERIES 130 2-LITE SLIDER

| MASONRY OPENING | 37 3/4" | 74 3/4" | 53 7/8" | 27 1/4" |
|-----------------|---------|---------|---------|---------|
| TIP TO TIP | 37 1/4" | 74 1/4" | 53 3/8" | 26 3/4" |
| EXACT SIZE | 36" | 73" | 52 1/8" | 25 1/2" |
| 26" | | | | |
| 26 1/4" | | | | |
| 25" | | | | |
| 38 3/8" | | | | |
| 38 5/8" | | | | |
| 37 3/8" | | | | |
| 50 5/8" | | | | |
| 50 7/8" | | | | |
| 49 5/8" | | | | |

| MASONRY OPENING | 37 3/4" | 49 3/4" | 61 3/4" | 73 3/4" |
|-----------------|---------|---------|---------|---------|
| TIP TO TIP | 37 1/4" | 49 1/4" | 61 1/4" | 73 1/4" |
| EXACT SIZE | 36" | 48" | 60" | 72" |
| 25" | | | | |
| 25 1/4" | | | | |
| 24" | | | | |
| 37" | | | | |
| 37 1/4" | | | | |
| 36" | | | | |
| 49" | | | | |
| 49 1/4" | | | | |
| 48" | | | | |

SERIES 130 2-LITE SLIDER















| Commodity Size | Masonry Opening Size | Tip to Tip Size | Exact Size |
|----------------|----------------------|-----------------|-----------------|
| 22 | 37 3/4 x 26 | 37 1/4 x 26 1/4 | 36 x 25 |
| 23 | 37 3/4 x 38 3/8 | 37 1/4 x 38 5/8 | 36 x 37 3/8 |
| 24 | 37 3/4 x 50 5/8 | 37 1/4 x 50 7/8 | 36 x 49 5/8 |
| DB22 | 74 3/4 x 26 | 74 1/4 x 26 1/4 | 73 x 25 |
| DB23 | 74 3/4 x 38 3/8 | 74 1/4 x 38 5/8 | 73 x 37 3/8 |
| DB24 | 74 3/4 x 50 5/8 | 74 1/4 x 50 7/8 | 73 x 49 5/8 |
| 32 | 53 7/8 x 26 | 53 3/8 x 26 1/4 | 52 1/8 x 25 |
| 33 | 53 7/8 x 38 3/8 | 53 3/8 x 38 5/8 | 52 1/8 x 37 3/8 |
| 34 | 53 7/8 x 50 5/8 | 53 3/8 x 50 7/8 | 52 1/8 x 49 5/8 |
| 1/32 | 27 1/4 x 26 | 26 3/4 x 26 1/4 | 25 1/2 x 25 |
| 1/33 | 27 1/4 x 38 3/8 | 26 3/4 x 38 5/8 | 25 1/2 x 37 3/8 |
| 1/34 | 27 1/4 x 50 5/8 | 26 3/4 x 50 7/8 | 25 1/2 x 49 5/8 |

| Commodity Size | Masonry Opening Size | Tip to Tip Size | Exact Size |
|----------------|----------------------|-----------------|------------|
| 3121 | 37 3/4 x 25 | 37 1/4 x 25 1/4 | 36 x 24 |
| 3131 | 37 3/4 x 37 | 37 1/4 x 37 1/4 | 36 x 36 |
| 3141 | 37 3/4 x 49 | 37 1/4 x 49 1/4 | 36 x 48 |
| 4121 | 49 3/4 x 25 | 49 1/4 x 25 1/4 | 48 x 24 |
| 4131 | 49 3/4 x 37 | 49 1/4 x 37 1/4 | 48 x 36 |
| 4141 | 49 3/4 x 49 | 49 1/4 x 49 1/4 | 48 x 48 |
| 5121 | 61 3/4 x 25 | 61 1/4 x 25 1/4 | 60 x 24 |
| 5131 | 61 3/4 x 37 | 61 1/4 x 37 1/4 | 60 x 36 |
| 5141 | 61 3/4 x 49 | 61 1/4 x 49 1/4 | 60 x 48 |
| 6121 | 73 3/4 x 25 | 73 1/4 x 25 1/4 | 72 x 24 |
| 6131 | 73 3/4 x 37 | 73 1/4 x 37 1/4 | 72 x 36 |
| 6141 | 73 3/4 x 49 | 73 1/4 x 49 1/4 | 72 x 48 |

SERIES 130 SLIDERS

130 3-Lite Sliders Egress Charts

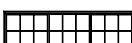
SERIES 130 3-LITE SLIDER EGRESS CHART

| ROUGH OPENING | 72" | 84" | 96" | 108" | |
|---------------|---|---|--|---|---|
| | EXACT SIZE | | | | |
| | 71.5" | 83.5" | 95.5" | 107.5" | |
| EGRESS WIDTH | | 20.5" | 24.5" | 28.5" | 32.5" |
| HEIGHT | 24" |  6020 |  7020 |  8020 |  9020 |
| | 23.5" | | | | |
| | 36" |  6030 |  7030 |  8030 |  9030 |
| | 35.5" | | | | |
| | 30" | | | | |
| 30.5" | | | | | |
| 48" |  6040 |  7040 |  8040 |  9040 | |
| 4.5" | | | | | |
| 42.5" | | | | | |
| 60" |  6050 |  7050 |  8050 |  9050 | |
| 59.5" | | | | | |
| 54.5" | | | | | |











SERIES 130 3-LITE SLIDER EGRESS CHART

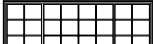







| NOM. SIZE | EGRESS WITH SASH | NOM. SIZE | EGRESS WITH SASH |
|-----------|------------------|-----------|------------------|
| 6020 | 2.64 | 8020 | 3.66 |
| 6030 | 4.22 | 8030 | 6.04 |
| 6040 | 6.06 | 8040 | 8.42 |
| 6050 | 7.77 | 8050 | 10.79 |
| 7020 | 3.15 | 9020 | 4.18 |
| 7030 | 5.19 | 9030 | 6.89 |
| 7040 | 7.24 | 9040 | 9.60 |
| 7050 | 9.28 | 9050 | 12.31 |

SERIES 130 SLIDERS

130 3-Lite Sliders Commodity Size Charts

SERIES 130 3-LITE SLIDER

| MASONRY OPENING | 73 3/4" | 85 3/4" | 97 3/4" |
|-----------------|---|---|---|
| TIP TO TIP | 73 1/4" | 85 1/4" | 97 1/4" |
| EXACT SIZE | 72" | 84" | 96" |
| 25" |  |  |  |
| 25 1/4" | | | |
| 24" | | | |
| 26" |  |  |  |
| 26 1/4" | | | |
| 25" | | | |
| 25 1/4" |  |  |  |
| 24" | | | |
| 25" |  |  |  |
| 25 1/4" | | | |
| 24" | | | |

| MASONRY OPENING | 73 3/4" | 107 1/8" |
|-----------------|---|---|
| TIP TO TIP | 73 1/4" | 106 5/8" |
| EXACT SIZE | 72" | 105 3/8" |
| 26" |  |  |
| 26 1/4" | | |
| 25" | | |
| 38 5/8" |  |  |
| 38 3/8" | | |
| 37 3/8" | | |
| 50 5/8" |  |  |
| 50 5/8" | | |
| 49 5/8" | | |
| 63" |  |  |
| 63" | | |
| 62" | | |

SERIES 130 3-LITE SLIDER

| Commodity Size | Masonry Opening Size | Tip to Tip Size | Exact Size |
|----------------|----------------------|-----------------|-------------|
| 6121C | 73 3/4 x 25 | 73 1/4 x 25 1/4 | 72 x 24 |
| 6131C | 73 3/4 x 37 | 73 1/4 x 37 1/4 | 72 x 36 |
| 6141C | 73 3/4 x 49 | 73 1/4 x 49 1/4 | 72 x 48 |
| 6151C | 73 3/4 x 61 | 73 1/4 x 61 1/4 | 72 x 60 |
| DB22 | 74 3/4 x 26 | 74 1/4 x 26 | 73 x 25 |
| DB23 | 74 3/4 x 38 3/8 | 74 1/4 x 38 3/8 | 73 x 37 3/8 |
| DB24 | 74 3/4 x 50 5/8 | 74 1/4 x 50 5/8 | 73 x 49 5/8 |
| DB25 | 74 3/4 x 63 | 74 1/4 x 63 | 73 x 62 |
| 7121C | 85 3/4 x 25 | 85 1/4 x 25 1/4 | 84 x 24 |
| 7131C | 85 3/4 x 37 | 85 1/4 x 37 1/4 | 84 x 36 |
| 7141C | 85 3/4 x 49 | 85 1/4 x 49 1/4 | 84 x 48 |
| 7151C | 85 3/4 x 61 | 85 1/4 x 61 1/4 | 84 x 60 |

| Commodity Size | Masonry Opening Size | Tip to Tip Size | Exact Size |
|----------------|----------------------|------------------|------------------|
| 8121C | 97 3/4 x 25 | 97 1/4 x 25 1/4 | 96 x 24 |
| 8131C | 97 3/4 x 37 | 97 1/4 x 37 1/4 | 96 x 36 |
| 8141C | 97 3/4 x 49 | 97 1/4 x 49 1/4 | 96 x 48 |
| 8151C | 97 3/4 x 61 | 97 1/4 x 61 1/4 | 96 x 60 |
| D32 | 107 1/8 x 26 | 106 5/8 x 26 | 105 3/8 x 25 |
| D33 | 107 1/8 x 38 3/8 | 106 5/8 x 38 3/8 | 105 3/8 x 37 3/8 |
| D34 | 107 1/8 x 50 5/8 | 106 5/8 x 50 5/8 | 105 3/8 x 49 5/8 |
| D35 | 107 1/8 x 63 | 106 4/8 x 63 | 163 3/8 x 62 |
| 9121C | 108 3/4 x 25 | 108 1/4 x 25 1/4 | 107 x 24 |
| 9131C | 108 3/4 x 37 | 108 1/4 x 37 1/4 | 107 x 36 |
| 9141C | 108 3/4 x 49 | 108 1/4 x 49 1/4 | 107 x 48 |
| 9151C | 108 3/4 x 61 | 108 1/4 x 61 1/4 | 107 x 60 |

SERIES 130 3-LITE SLIDER COMMODITY EGRESS CHART

| Commodity Size | Tip to Tip Size | Exact Size | 1/4, 1/2, 1/4 | Sq. Feet | 1/3, 1/3, 1/3 | Sq. Feet |
|----------------|------------------|------------|---------------|----------|---------------|----------|
| 6121C | 73 1/4 x 25 1/4 | 72 x 24 | 14 2/16 x 19 | 1.86 | 20 6/8 x 19 | 2.73 |
| 6131C | 73 1/4 x 37 1/4 | 72 x 36 | 14 2/16 x 31 | 3.04 | 20 6/8 x 31 | 4.45 |
| 6141C | 73 1/4 x 49 1/4 | 72 x 48 | 14 2/16 x 43 | 4.22 | 20 6/8 x 43 | 6.18 |
| 6151C | 73 1/4 x 61 1/4 | 72 x 60 | 14 2/16 x 55 | 5.39 | 20 6/8 x 55 | 7.90 |
| 7121C | 85 1/4 x 25 1/4 | 84 x 24 | 17 2/16 x 19 | 2.26 | 24 6/8 x 19 | 3.26 |
| 7131C | 85 1/4 x 37 1/4 | 84 x 36 | 17 2/16 x 31 | 3.69 | 24 6/8 x 31 | 5.31 |
| 7141C | 85 1/4 x 49 1/4 | 84 x 48 | 17 2/16 x 43 | 5.11 | 24 6/8 x 43 | 7.37 |
| 7151C | 85 1/4 x 61 1/4 | 84 x 60 | 17 2/16 x 55 | 6.54 | 24 6/8 x 55 | 9.43 |
| 8121C | 97 1/4 x 25 1/4 | 96 x 24 | 20 2/16 x 19 | 2.66 | 28 6/8 x 19 | 3.79 |
| 8131C | 97 1/4 x 37 1/4 | 96 x 36 | 20 2/16 x 31 | 4.33 | 28 6/8 x 31 | 6.18 |
| 8141C | 97 1/4 x 49 1/4 | 96 x 48 | 20 2/16 x 43 | 6.01 | 28 6/8 x 43 | 8.57 |
| 8151C | 97 1/4 x 61 1/4 | 96 x 60 | 20 2/16 x 55 | 7.69 | 28 6/8 x 55 | 10.96 |
| 9121C | 108 1/4 x 25 1/4 | 107 x 24 | 22 14/16 x 19 | 3.02 | 32 1/4 x 19 | 4.27 |
| 9131C | 108 1/4 x 37 1/4 | 107 x 36 | 22 14/16 x 31 | 4.92 | 32 1/4 x 31 | 6.97 |
| 9141C | 108 1/4 x 49 1/4 | 107 x 48 | 22 14/16 x 43 | 6.83 | 32 1/4 x 43 | 9.66 |
| 9151C | 108 1/4 x 61 1/4 | 107 x 60 | 22 14/16 x 55 | 8.74 | 32 1/4 x 55 | 12.36 |

Series 130 HS vertical diagram

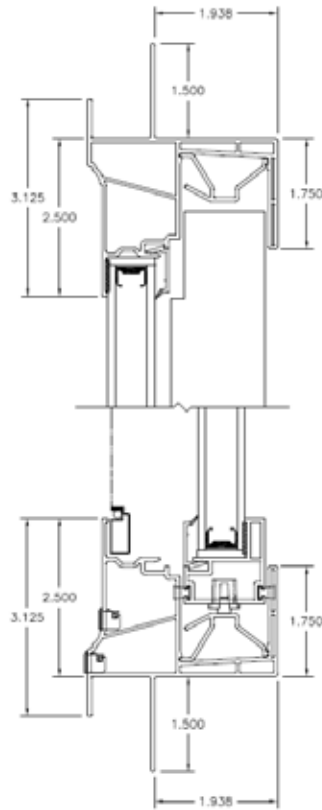

Series 130 horizontal diagram (OX)

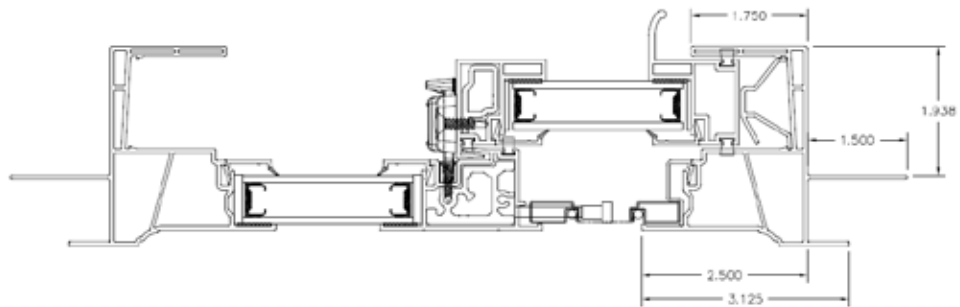

Series 130 horizontal diagram (XOX)

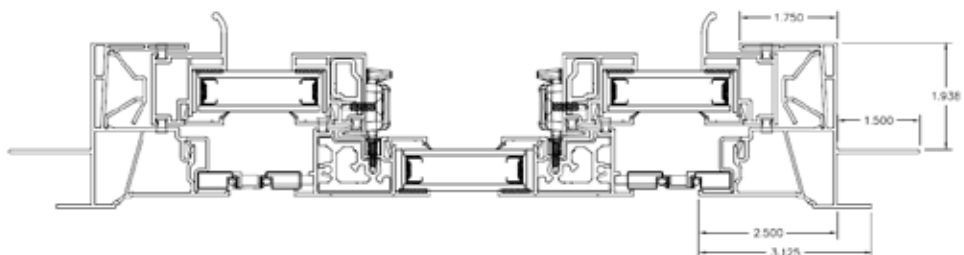

SERIES 130 SLIDERS

Series 130 HS horizontal diagram (OX) Box

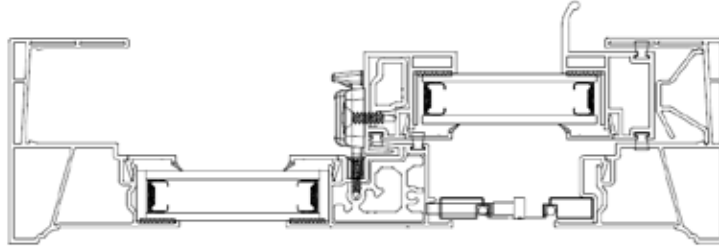

Series 130 HS horizontal diagram (XOX) Box

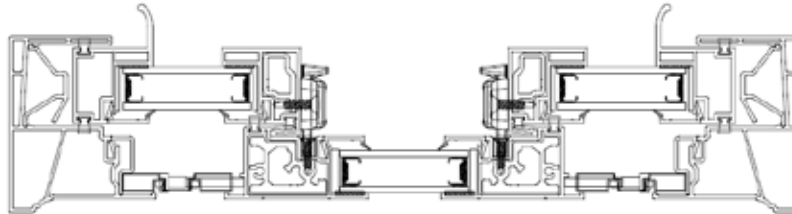

Series 130 HS horizontal diagram (OX) Fin Only

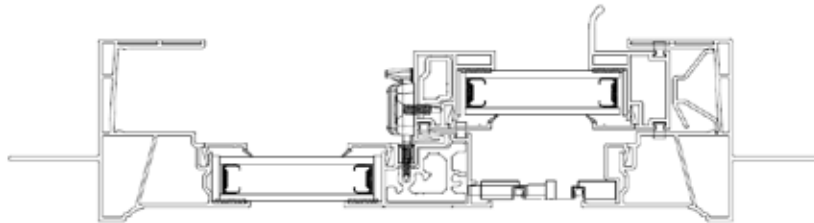

Series 130 HS horizontal diagram (XOX) Fin Only

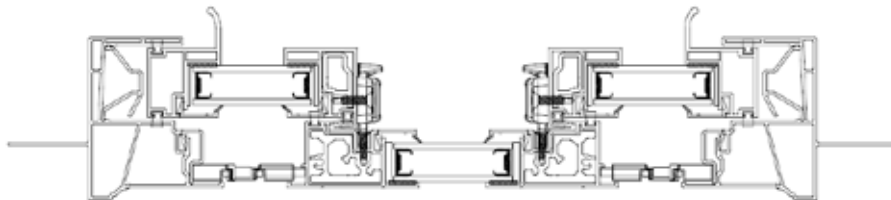

Features:

- Cam locks are standard.
- Double locks are featured on all windows measuring more than 27 1/4" in height.
- Integrated J-channel assists in the installation of vinyl siding for the Series 151. The Series 161 does not have a J-channel.
- Pre Punched nailing fin allows for faster installation.
- Half screen is standard.
- DP Ratings:
R-30 (window size tested 72" x 48")
R-25 (window size tested 108" x 60") (XOX)

Custom Options:

- Low-E Glass and Argon Gas.
- Ultra Low-E Argon.
- Almond and Clay vinyl colors.
- Nine painted exterior colors (white interior only).
- 5/8" or 1" contoured, 5/8" or 3/4" flat, 1 1/8" Simulated Divided Lite (SDL) grids.
- Factory mulling of twins, triples and architectural shapes.
- Foamed PVC jamb extensions (pre-primed or stainable 4 9/16" and 6 9/16").

Materials:

- Frame is maintenance free, color stabilized solid vinyl (PVC).
- The screen is comprised of roll formed aluminum frame and fiberglass mesh.
- Glazing method: Glazing tape.

Mulled Units:

Factory mulling over a slider provides easier installation without extra labor or material costs.

Aluminum reinforcement is standard in factory mulled units.

Window Construction:

Frame and sashes are fusion welded to protect against air and water infiltration. Fusion adds strength and squareness to the window.

Foamed PVC Jamb Extension:

The interior foamed PVC jamb extension is available in pre-primed or stainable version for your convenience and ease of installation for a frame thickness of either 4 9/16" or 6 9/16".

SERIES 151/161 SLIDERS

Series 151 2-Lite and 3-Lite
vertical diagram

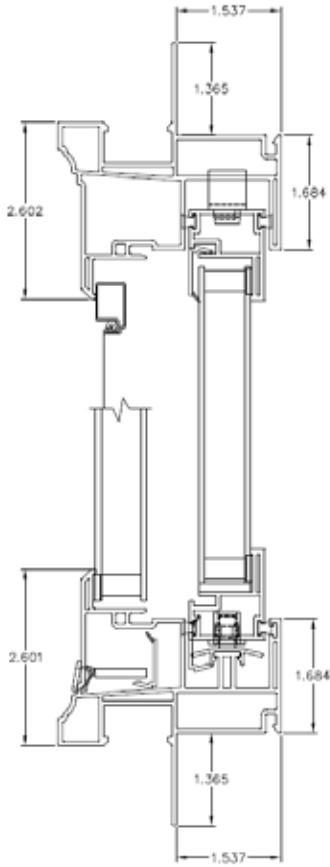

Series 161 2-Lite and 3-Lite
vertical diagram

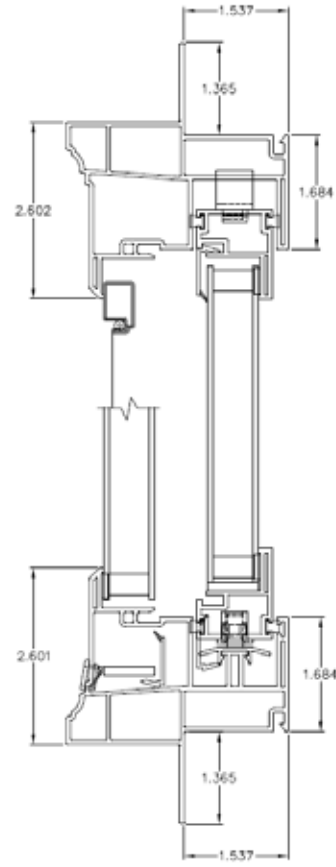

Series 151 2-Lite
horizontal diagram

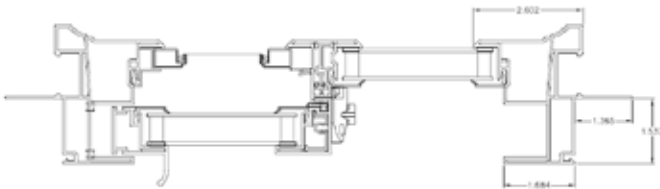

Series 151 3-Lite
horizontal diagram

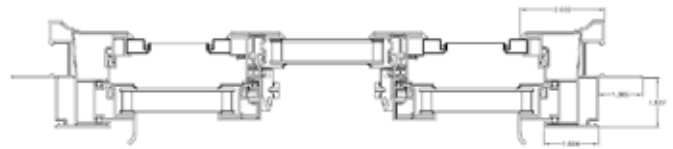

Series 161 2-Lite
horizontal diagram

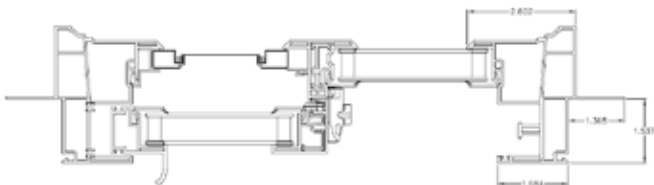



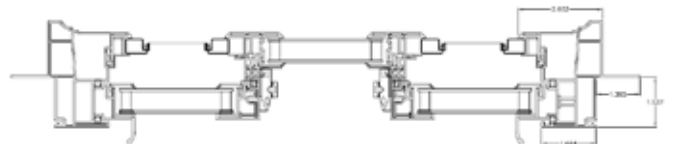

























Series 161 3-Lite
horizontal diagram



SERIES 151/161 SLIDERS

Series 151/161 2-Lite Sliders Egress Charts

SERIES 151/161 2-LITE SLIDER EGRESS CHART

| ROUGH OPENING | 24" | 36" | 48" | 60" | 72" |
|---------------|--|---|---|--|---|
| EXACT SIZE | 23.5" | 35.5" | 47.5" | 59.5" | 71.5" |
| EGRESS WIDTH | 7.75" | 13.75" | 19.75" | 25.75" | 31.75" |
| HEIGHT | | | | | |
| 24" |  2020 |  3020 |  4020 |  5020 |  6020 |
| 36" |  2030 |  3030 |  4030 |  5030 |  6030 |
| 40" |  2034 |  3034 |  4034 |  5034 |  6034 |
| 42" |  2036 |  3036 |  4036 |  5036 |  6036 |
| 48" |  2040 |  3040 |  4040 |  5040 |  6040 |
| 60" | |  3050 |  4050 |  5050 |  6050 |

SERIES 151/161 2-LITE SLIDER EGRESS CHART

| NOM. SIZE | EGRESS WITH SASH | NOM. SIZE | EGRESS WITH SASH |
|-----------|------------------|-----------|------------------|
| 2020 | 1.0 | 5020 | 3.4 |
| 2030 | 1.7 | 5030 | 5.5 |
| 2034 | 1.9 | 5034 | 6.3 |
| 2036 | 2.0 | 5036 | 6.6 |
| 2040 | 2.4 | 5040 | 7.7 |
| 3020 | 1.8 | 5050 | 9.9 |
| 3030 | 3.0 | 6020 | 4.1 |
| 3034 | 3.4 | 6030 | 6.8 |
| 3036 | 3.6 | 6034 | 7.7 |
| 3040 | 4.1 | 6036 | 8.1 |
| 3050 | 5.3 | 6040 | 9.5 |
| 4020 | 2.6 | 6050 | 12.1 |
| 4030 | 4.3 | | |
| 4034 | 4.8 | | |
| 4036 | 5.1 | | |
| 4040 | 5.9 | | |
| 4050 | 7.6 | | |

SERIES 151/161 SLIDERS

Series 151/161 3-Lite Sliders Egress Charts

SERIES 151/161 3-LITE SLIDER EGRESS CHART

| ROUGH OPENING | 72" | 84" | 96" | 108" |
|---------------|--------|--------|--------|--------|
| EXACT SIZE | 71.5" | 83.5" | 95.5" | 107.5" |
| EGRESS WIDTH | 15.63" | 18.63" | 21.63" | 24.63" |
| HEIGHT | 36" | 36" | 36" | 36" |
| 35.5" | | | | |
| 30.63" | 6030 | 7030 | 8030 | 9030 |
| 40" | | | | |
| 39.5" | 6034 | 7034 | 8034 | 9034 |
| 34.63" | | | | |
| 42" | 6036 | 7036 | 8036 | 9036 |
| 41.5" | | | | |
| 42" | 6040 | 7040 | 8040 | 9040 |
| 47.5" | | | | |
| 42.63" | 6050 | 7050 | 8050 | |
| 60" | | | | |
| 59.5" | | | | |
| 54.63" | | | | |

SERIES 151/161 3-LITE SLIDER EGRESS CHART

| NOM. SIZE | EGRESS WITH SASH | NOM. SIZE | EGRESS WITH SASH |
|-----------|------------------|-----------|------------------|
| 6030 | 4.22 | 8030 | 5.92 |
| 6034 | 4.77 | 8034 | 6.69 |
| 6036 | 5.04 | 8036 | 7.08 |
| 6040 | 5.87 | 8040 | 8.24 |
| 6050 | 7.52 | 8050 | 10.56 |
| 7030 | 5.07 | 9030 | 6.77 |
| 7034 | 5.73 | 9034 | 7.65 |
| 7036 | 6.06 | 9036 | 8.10 |
| 7040 | 7.05 | 9040 | 9.42 |
| 7050 | 9.04 | | |

Features:

- Double locks are featured on all windows measuring more than 27 1/4" in height.
- There are heavy duty lift rails on each sash.
- Half screen is standard. Full screens are options.
- Integrated J-channel assists in installation of vinyl siding for the Series 451. The Series 461 does not have a J-channel.
- DP Ratings:
R-25 (window size tested 70" x 49")
R-25 (window size tested 96" x 48") (XOX)

Custom Options:

- Low-E Glass and Argon Gas.
- Ultra Low-E Argon.
- Almond and Clay vinyl colors.
- Nine painted exterior colors (white interior only).
- 5/8" or 1" contoured, 5/8" or 3/4" flat grid or 1 1/8" Simulated Divided Lite (SDL) grids.
- Factory mulling of twins, triples and architectural shapes.
- Foamed PVC jamb extensions (pre-primed or stainable 4 9/16" and 6 9/16").
- 3 1/4" Flat Casing with Bull Nose.

Materials:

- Frame and sash is maintenance free, color stabilized solid vinyl (PVC).
- All lock rails contain aluminum rebar for additional strength.
- The screen is comprised of an extruded aluminum frame and fiberglass mesh.
- Glazing method: Glazing tape.

Mulled Units:

Factory mulling over a slider provides easier installation without extra labor or material costs.

Window Construction:

Frame and sashes are fusion welded to protect against air and water infiltration. Fusion adds strength and squareness to the window.

Foamed PVC Jamb Extension:

The interior foamed PVC jamb extension is available in pre-primed or stainable version for your convenience and ease of installation for a frame thickness of either 4 9/16" or 6 9/16".

SERIES 451/461 SLIDERS

Series 451 2SL 2-Lite and 3SL 3-Lite
vertical diagram

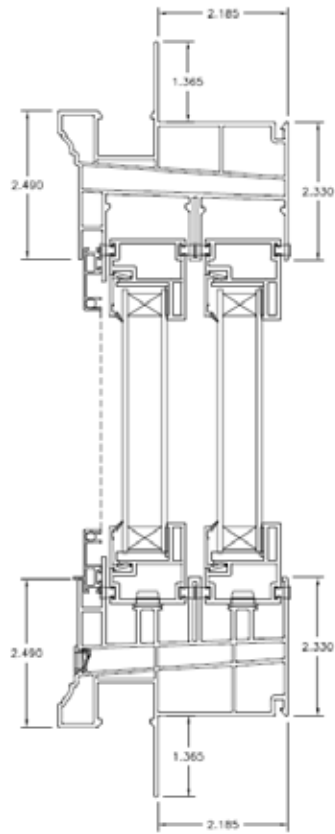

Series 461 2SL 2-Lite and 3SL 3-Lite
vertical diagram

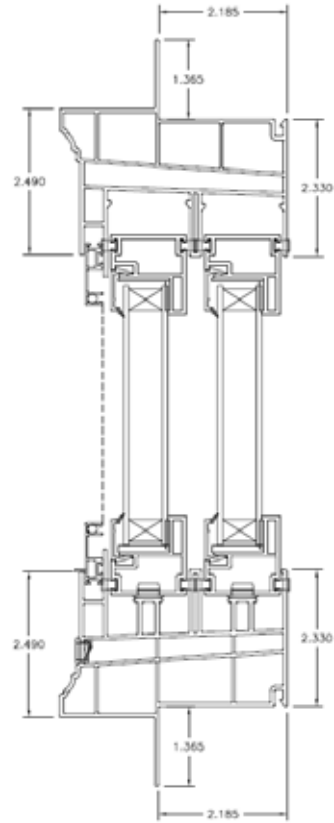

Series 451 2-Lite horizontal diagram

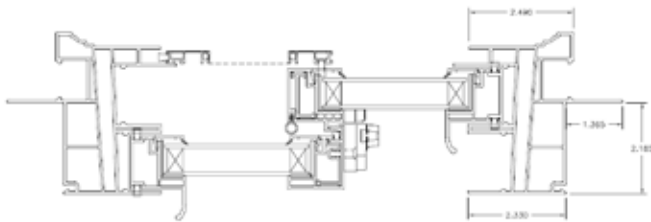

Series 451 3-Lite horizontal diagram

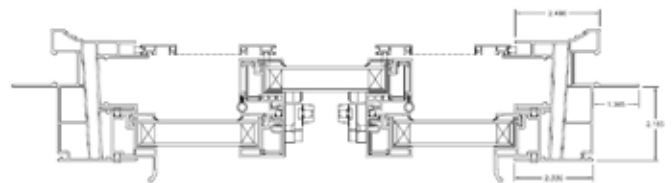

Series 461 2-Lite horizontal diagram

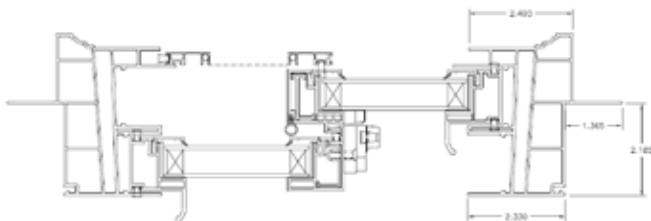



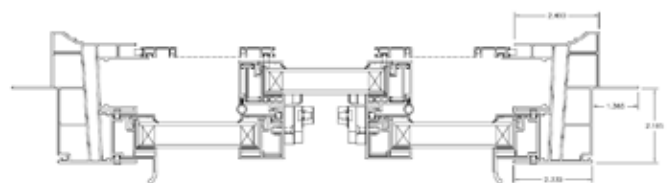



























Series 461 3-Lite horizontal diagram



SERIES 451/461 SLIDERS

Series 451/461 2-Lite Slider Egress Charts

SERIES 451/461 2-LITE SLIDER EGRESS CHART











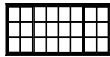
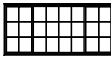
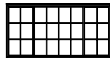
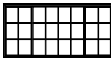
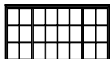
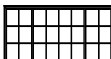
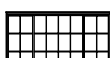



| ROUGH OPENING | 24" | 36" | 48" | 60" |
|---------------|---|---|---|---|
| EXACT SIZE | 23.5" | 35.5" | 47.5" | 59.5" |
| EGRESS WIDTH | 6.1875" | 12.1875" | 18.1875" | 24.1875" |
| HEIGHT | | | | |
| 32" |  2028 |  3028 |  4028 |  5028 |
| 38" |  2032 |  3032 |  4032 |  5032 |
| 40" |  2034 |  3034 |  4034 |  5034 |
| 42" |  2036 |  3036 |  4036 |  5036 |
| 46" |  20310 |  30310 |  40310 |  50310 |
| 50" |  2042 |  3042 |  4042 |  5042 |
| 54" |  2046 |  3046 |  4046 |  5046 |
| 62" | |  3052 |  4052 |  5052 |

SERIES 451/461 2-LITE SLIDER EGRESS CHART

| NOM. SIZE | EGRESS WITH SASH | NOM. SIZE | EGRESS WITH SASH |
|-----------|------------------|-----------|------------------|
| 2028 | 1.1 | 4028 | 3.3 |
| 2032 | 1.4 | 4032 | 4.1 |
| 2034 | 1.5 | 4034 | 4.3 |
| 2036 | 1.6 | 4036 | 4.6 |
| 20310 | 1.7 | 40310 | 5.1 |
| 2042 | 1.9 | 4042 | 5.6 |
| 2046 | 2.1 | 4046 | 6.1 |
| 3028 | 2.2 | 4052 | 7.1 |
| 3032 | 2.7 | 5028 | 4.4 |
| 3034 | 2.9 | 5032 | 5.4 |
| 3036 | 3.1 | 5034 | 5.7 |
| 30310 | 3.4 | 5036 | 6.1 |
| 3042 | 3.7 | 50310 | 6.7 |
| 3046 | 4.1 | 5042 | 7.4 |
| 3052 | 4.8 | 5046 | 8.1 |
| | | 5052 | 9.4 |

Series 451/461 3-Lite Slider Egress Charts

SERIES 451/461 3-LITE SLIDER EGRESS CHART

| ROUGH OPENING | 72" | 84" | 96" | 108" |
|---------------|--|--|--|---|
| EXACT SIZE | 71.5" | 83.5" | 95.5" | 107.5" |
| EGRESS WIDTH | 15.625" | 18.625" | 21.625" | 24.625" |
| HEIGHT | | | | |
| 32" | 31.5"  6028 | 26.125"  7028 | | |
| 38" | 37.5"  6032 | 32.125"  7032 | | |
| 40" | 39.5"  6034 | 34.125"  7034 | | |
| 42" | 41.5"  6036 | 36.125"  7036 | | |
| 46" | 45.5"  60310 | 40.125"  70310 | | |
| 50" | 49.5"  6042 | 44.125"  7042 |  8042 |  9042 |
| 54" | 53.5"  6046 | 48.125"  7046 |  8046 | |
| 62" | 61.5"  6052 | 56.125"  7052 |  8052 | |
| 74" | 73.5"  6062 | | | |

SERIES 451/461 3-LITE SLIDER EGRESS CHART

| NOM. SIZE | EGRESS WITH SASH | NOM. SIZE | EGRESS WITH SASH |
|-----------|------------------|-----------|------------------|
| 6028 | 2.8 | 7028 | 3.3 |
| 6032 | 3.4 | 7032 | 4.1 |
| 6034 | 3.6 | 7034 | 4.3 |
| 6036 | 3.8 | 7036 | 4.6 |
| 60310 | 4.3 | 70310 | 5.1 |
| 6042 | 4.7 | 7042 | 5.6 |
| 6046 | 5.1 | 7046 | 6.1 |
| 6052 | 6.0 | 7052 | 7.1 |
| 6062 | 7.2 | 8042 | 6.6 |
| | | 8046 | 7.1 |
| | | 8052 | 8.3 |
| | | 9042 | 7.5 |

Features:

- Brick mould exterior frame design.
- Collapsible handle folds into assembly cover.
- Superb design and engineering help prevent air and water infiltration.
- Fusion-welded frame and sash ensure weathertight performance.
- Full-perimeter double weather stripping adds extra tightness.
- Narrow profile permits expanded viewing area.
- Concealed hinges and hardware let you open window 90 degrees, for better ventilation and easier cleaning.
- Full screens come standard; mount on interior, remove for easy cleaning.
- Tandem locks come standard on all casements over 32" in height.
- Right or left hinges are available (looking from outside to inside).
- Integrated nailing fin permits easy installation.
- White is standard.
- DP-55 Rating
(window size tested 36" x 72")

Custom Options:

- Low-E Glass and Argon Gas
- Ultra Low-E Argon.
- 5/8" or 1" contoured, 5/8" or 3/4" flat, 5/8" contoured valance and 1 1/8" Simulated Divided Lite (SDL) grids.
- Almond and Clay vinyl colors.
- Nine painted exterior colors (white interior only).
- Special shapes are available.
- Factory mulling available for your convenience and ease of installation.
- Egress Hinge to allow larger area of egress.
- Foamed PVC jamb extensions (pre-primed or stainable 4 9/16" and 6 9/16").
- 2" Simulated Meeting Rail.

Materials:

- Frame and sash are maintenance free, color stabilized solid vinyl (PVC).
- The screen is comprised of an extruded aluminum frame and fiber glass mesh.
- Glazing method: Silicone caulk.

CASEMENT WINDOWS

| SERIES | 750 1LT Single |
|------------------------------|------------------------|
| VINYL WALL THICKNESS | 0.075" (1.91MM) |
| GLASS THICKNESS | 0.750" (19.05MM) |
| JAMB THICKNESS | 3.250" (82.55MM) |
| FRAME WIDTH (INTERIOR) | 2.625" (66.68MM) |
| FRAME WIDTH (EXTERIOR) | 0.762" (19.35MM) |
| NAILING FIN SETBACK | 2.175" (55.25MM) |
| NAILING FIN LENGTH | 1.25" (31.75MM) |
| EGRESS WIDTH (REGULAR HINGE) | (WW) - 11 3/4" |
| EGRESS WIDTH (EGRESS HINGE) | (WW) - 7 1/4" |
| EGRESS HEIGHT | (WH) - 5 3/16" |
| DAYLIGHT OPENING WIDTH | (WW) - 6 1/8" |
| DAYLIGHT OPENING HEIGHT | (WH) - 6 1/8" |
| SCREEN WIDTH | (WW) - 4 1/4" |
| SCREEN HEIGHT | (WH) - 4 1/4" |
| OPTIONS GLASS: | |
| CLEAR (STANDARD) | • |
| LOW-E WITH ARGON | • |
| ULTRA LOW-E WITH ARGON | • |
| OBSCURE | • |
| TEMPERED | • |
| DOUBLE STRENGTH | • |
| OPTIONS GAS: | |
| ARGON | • |
| AVAILABLE SPECIAL SHAPES: | |
| FULL ROUNDS | QUARTER ROUNDS |
| HALF ROUNDS | ELLIPTICALS |
| OCTAGONS | PENTAGONS |
| TRAPEZOIDS | TRIANGLES |
| HALF EYEBROWS | EYEBROWS |
| COLONIAL ARCHES | COLONIAL FLANKERS |
| | COLONIAL ARCH FLANKERS |

(WW) = WINDOW WIDTH
 (WH) = WINDOW HEIGHT

CASEMENT WINDOWS

Series 750 vertical diagram

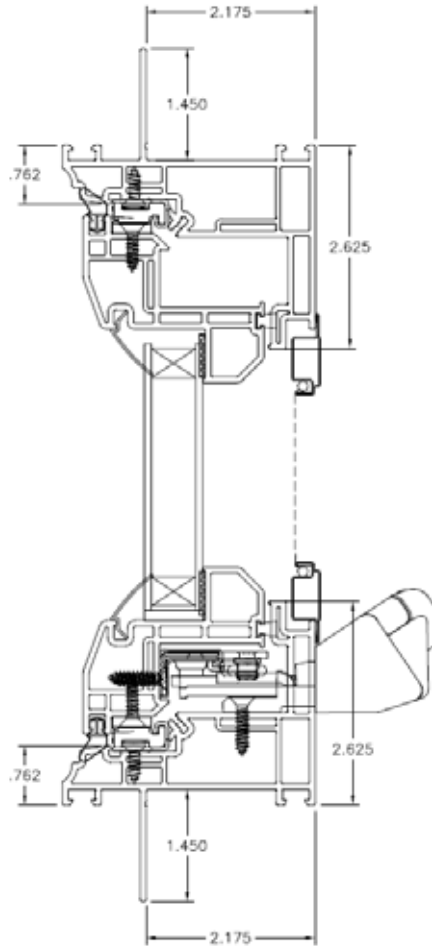

Series 750 horizontal diagram

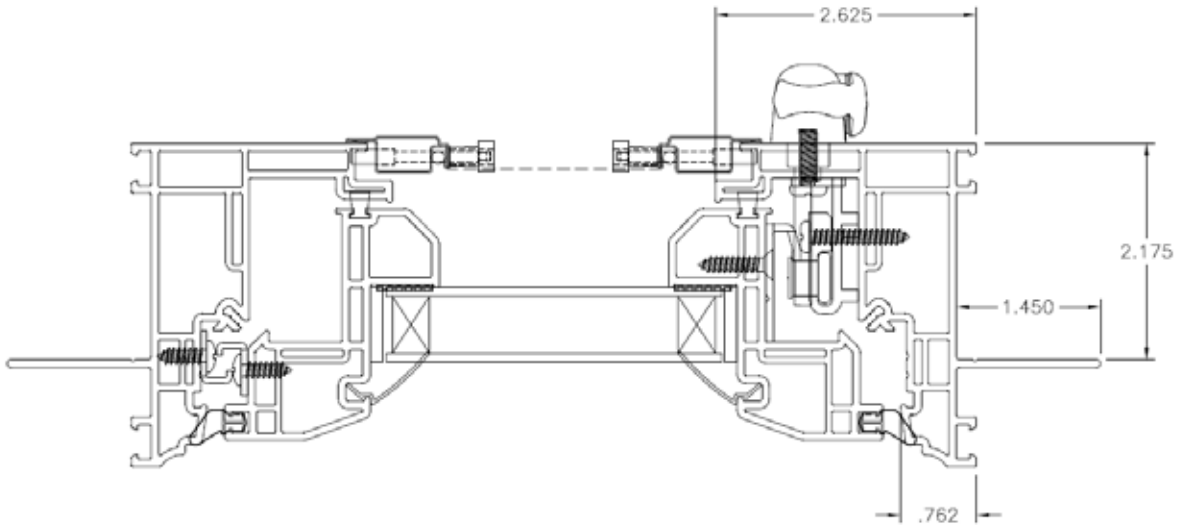

CASEMENT WINDOWS

750 1-Lite Single Casement Size Chart

SERIES 750 1-LITE SINGLE CASEMENT GRID CHART

| ROUGH OPENING | 18" | 20" | 24" | 28" | 30" | 32" | 36" |
|---------------|-------|-------|-------|-------|-------|-------|-------|
| EXACT SIZE | 17.5" | 19.5" | 23.5" | 27.5" | 29.5" | 31.5" | 35.5" |
| 24" | 1620 | 1820 | 2020 | 2420 | | 2820 | 3020 |
| 36" | 1630 | 1830 | 2030 | 2430 | | 2830 | 3030 |
| 42" | 1636 | 1836 | 2036 | 2436 | | 2836 | 3036 |
| 48" | 1640 | 1840 | 2040 | 2440 | 2640 | 2840 | 3040 |
| 54" | 1646 | 1846 | 2046 | 2446 | 2646 | 2846 | 3046 |
| 60" | 1650 | 1850 | 2050 | 2450 | 2650 | 2850 | 3050 |
| 66" | 1656 | 1856 | 2056 | 2456 | 2656 | 2856 | 3056 |
| 68" | 1658 | 1858 | 2058 | 2458 | | | |

750 1-Lite Single Casement Egress Chart





































SERIES 750 1-LITE SINGLE CASEMENT EGRESS CHART (WITH STANDARD HARDWARE) Egress hardware available.

| NOM. SIZE | OPENING SQUARE FEET | NOM. SIZE | OPENING SQUARE FEET | NOM. SIZE | OPENING SQUARE FEET |
|-----------|---------------------|-----------|---------------------|-----------|---------------------|
| 1620 | N/A | 2046 | N/A | 2846 | 6.6 |
| 1630 | N/A | 2050 | N/A | 2850 | 7.5 |
| 1636 | N/A | 2056 | N/A | 2856 | 8.3 |
| 1640 | N/A | 2058 | N/A | 3020 | 3.0 |
| 1646 | N/A | 2420 | 2.0 | 3030 | 5.0 |
| 1650 | N/A | 2430 | 3.3 | 3036 | 6.0 |
| 1656 | N/A | 2436 | 4.0 | 3040 | 7.0 |
| 1658 | N/A | 2440 | 4.6 | 3046 | 8.0 |
| 1820 | N/A | 2446 | 5.3 | 3050 | 9.0 |
| 1830 | N/A | 2450 | 6.0 | 3056 | 11.0 |
| 1836 | N/A | 2456 | 6.6 | | |
| 1840 | N/A | 2458 | 6.8 | | |
| 1846 | N/A | 2640 | 5.2 | | |
| 1850 | N/A | 2646 | 6.0 | | |
| 1856 | N/A | 2650 | 6.7 | | |
| 1858 | N/A | 2656 | 7.4 | | |
| 2020 | N/A | 2820 | 2.5 | | |
| 2030 | N/A | 2830 | 4.2 | | |
| 2036 | N/A | 2836 | 5.0 | | |
| 2040 | N/A | 2840 | 5.8 | | |

CASEMENT WINDOWS

750 2-Lite Twin Casement Size Chart

SERIES 750 2-LITE TWIN CASEMENT GRID CHART

| ROUGH OPENING | | 36" | 42" | 48" | 56" | 60" |
|---------------|-------|---|---|---|--|---|
| EXACT SIZE | | 35.5" | 41.5" | 47.5" | 55.5" | 59.5" |
| 24" | 23.5" |  3020 |  3620 |  4020 | |  5020 |
| 36" | 35.5" |  3030 |  3630 |  4030 | |  5030 |
| 42" | 41.5" |  3036 |  3636 |  4036 | |  5036 |
| 48" | 47.5" |  3040 |  3640 |  4040 |  4840 |  5040 |
| 54" | 53.5" |  3046 |  3646 |  4046 |  4846 |  5046 |
| 60" | 59.5" |  3050 |  3650 |  4050 |  4850 |  5050 |
| 66" | 65.5" |  3056 |  3656 |  4056 |  4856 |  5056 |
| 68" | 67.5" |  3058 |  3658 |  4058 |  4858 |  5058 |

Features:

- Brick mould exterior frame design.
- Collapsible handle folds into assembly cover.
- Fine-tuned, proven design ensures weathertight performance.
- Fusion-welded frame and sash further reduce air and water infiltration.
- Full-perimeter double weather stripping surrounds 3/4" insulated glass to provide maximum energy efficiency.
- Interior-mounted full screen and double locks come standard.
- Double locks standard on all awnings.
- Integrated nailing on new construction applications.
- Concealed hinges and operation hardware provide a clean unobstructed view.
- Frames and sashes are fusion welded for a clean look and added strength.
- White is standard.

Custom Options:

- Low-E Glass and Argon Gas.
- Ultra Low-E Argon.
- 5/8" or 1" contoured, 5/8" or 3/4" flat, 5/8" contoured valance and 1 1/8" Simulated Divided Lite (SDL) grids.
- Almond and Clay vinyl colors.
- Nine painted exterior colors (white interior only).
- Special shapes are available.
- Factory mulling available for your convenience and ease of installation.
- Foamed PVC jamb extensions (pre-primed or stainable 4 9/16" and 6 9/16").

Materials:

- Frame and sash are maintenance free, color stabilized solid vinyl (PVC).
- Screen is an extruded aluminum frame with fiber glass mesh.
- Glazing method: Silicone caulk.

AWNING

Single Vent Awning

2 LTH 2-Wide Awning

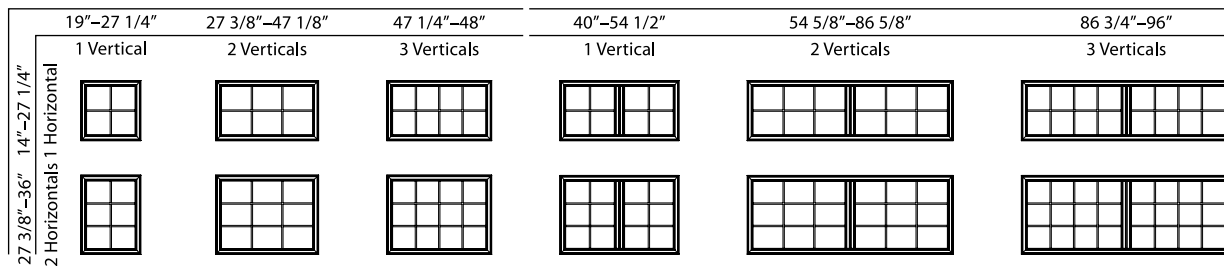

2 LTV Stacked Awning

3 LTV Stacked Awning

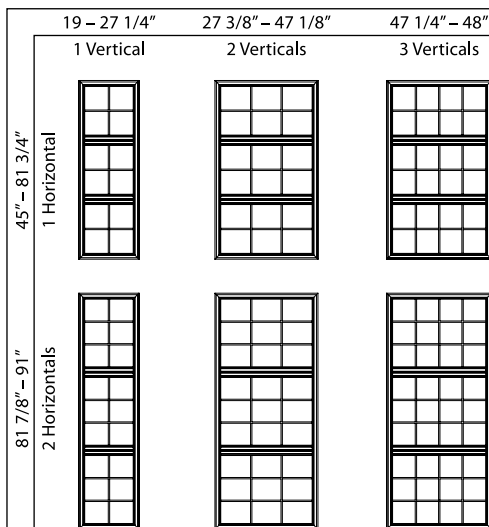
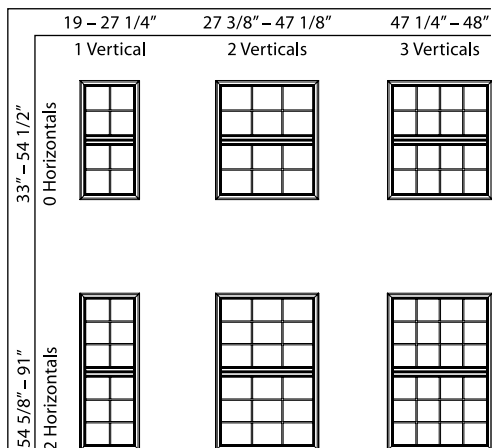

3 LTH 3-Wide Awning

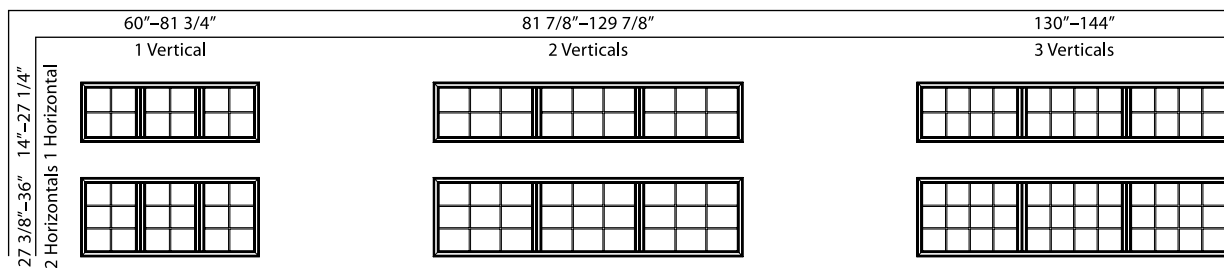

Dead Lite Over Awning (Equal Lite)

Dead Lite Over Awning (Cottage & Oriel)

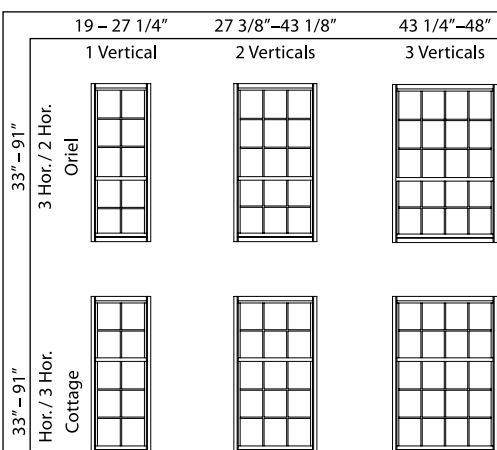
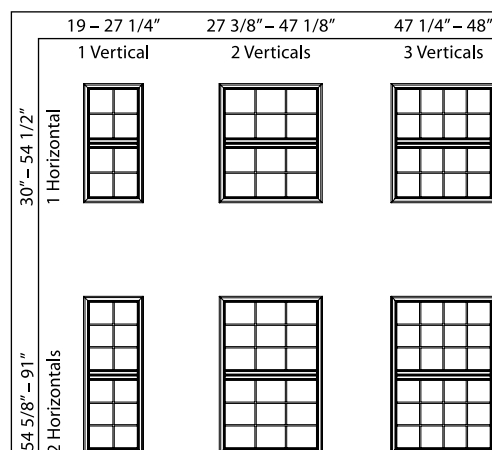

Features:

- Pre-assembled for easy installation with reversible moving panel.
- Pre-punched nail fin for easy new construction applications simply removes for replacement projects.
- 7/8" tempered glass panels for energy efficiency and safety.
- Limited lifetime warranty.
- White enamel handle with lock is standard for the 311.
- Color matched handle with keyed lock is standard for the 312 and 332.
- The 311 is available in 5', 6', and 6'4" widths, while the 312 and 332 series are available in 5', 6', 6'4", 8', 9', and 12' widths.
- The 332 has a 8'0" height available in 5', 6', and 6'4" widths.
- The 311 comes in white only, while it is standard for the 312 and 332.
- A factory installed screen is optional for the 311 and is standard with the 312 and 332.
- 332 jamb depth 5.5625"; 311 and 312 jamb depth 4.5625".
- The 332 has a DP-50 rating for the 5068, 5080, 6068, 6080 and 8068 series.
- The 332 has a multi-point lock mechanism.
- White is standard.

Custom Options:

- Low-E Glass and Argon Gas.
- Ultra Low-E Argon.
- Non-reflective Glass.
- 5/8" or 1" contoured, or 5/8" or 3/4" flat grid between the panes for easy glass cleaning; 1 1/8" simulated divided lite (for 312 & 322).
- 4 9/16" pre-primed and 6 9/16" extender kits are available for the 311 and 312 while 6 9/16" extender kits are available for the 332.
- The 312 and 332 are available with Black or Bronze exterior (white interior only; not available on 3 or 4-lite doors).
- Exclusive options for the 332 include foot bolt lock, and field applied flat or brick mould J-channel.
- Custom sizes are available (for 312 & 332).
- Almond and Clay vinyl colors (for 312 & 332).
- Nine painted exterior colors (white interior only; 312 & 332).
- Blinds Between the Glass (for 312 & 332).
- Polished Brass, Brushed Nickel or Oil Rubbed Bronze Handles.
- Pet resistant screen.

Materials:

- Frame and sash are maintenance free, color stabilized solid vinyl (PVC).
- The sash and fixed meeting rail contain steel rebar for added strength.
- Glazing method: Glazing tape.

Structural Performance

| SERIES | TEST SIZE | AIR | WATER | LOAD | DESIGN PRESSURE |
|------------|-------------------|------|-------|-------|-----------------------------|
| 311/312 | 70 3/4" X 79 1/2" | 0.12 | 6.75 | 52.50 | SGD-R35 71 X 80 |
| 312 | 94 3/4" X 79 1/2" | 0.12 | 4.50 | 37.50 | SGD-R25 95 X 80 |
| 332 | 72" X 96" | 0.16 | 7.50 | 75.00 | SGD-R50 72 X 96 |
| 312 Custom | 70 3/4" X 81 1/2" | 0.12 | 6.75 | 52.50 | SGD-DP35 70 3/4 X 81 1/2 |
| 332 Custom | 70 3/4" X 81 1/2" | 0.16 | 7.50 | 75.00 | SGD-DP50 70 3/4 X 81 1/2 |

SLIDING PATIO DOORS

| SERIES | 311 | 312 | 332 |
|----------------------------|--|--|--|
| VINYL WALL THICKNESS FRAME | 0.070" (1.78MM) | 0.070" (1.78MM) | 0.090" (2.29MM) |
| VINYL WALL THICKNESS SASH | 0.080" (2.03MM) | 0.080" (2.03MM) | 0.080" (2.03MM) |
| GLASS THICKNESS | 0.813" (20.65 MM) | 0.813" (20.65 MM) | 0.813" (20.65MM) |
| JAMB THICKNESS | 4.563" (115.90MM) | 4.563" (115.90MM) | 5.633" (143.08MM) |
| FRAME WIDTH EXTERIOR | 1.00" (25.40MM) | 1.00" (25.40MM) | 1.132" (28.70MM) |
| FRAME WIDTH INTERIOR | 1.718" (43.64MM) | 1.718" (43.64MM) | 2.00" (50.80MM) |
| NAILING FIN LENGTH | 1.0" (25.40MM) | 1.0" (25.40MM) | 1.671" (42.44MM) |
| NAIL FIN SETBACK | 3.368" (85.55MM) | 3.368" (85.55MM) | 4.563" (115.90MM) |
| EGRESS WIDTH | 5' = 22 1/2" 6' = 28 1/2" 6'4" = 32" | 5' = 22 1/2" 6' = 28 1/2" 6'4" = 32" 8' = 40 1/2" | 5' = 22 3/4" 6' = 28 3/4" 6'4" = 32 3/8" 8' = 40 3/4" |
| EGRESS HEIGHT | 76" | 76" | 6'8" = 75 1/2" 8' = 95 1/2" |
| SCREEN SIZE | 5068 = 30" x 77 1/16" 6068 = 36" x 77 1/16" 6468 = 38" x 77 1/16" 8068 = 48" x 77 1/16" | 5068 = 30" x 77 1/16" 6068 = 36" x 77 1/16" 6468 = 38" x 77 1/16" 8068 = 48" x 77 1/16" | 5068 = 30 1/2" x 77 1/2" 6068 = 36 1/2" x 77 1/2" 6468 = 38 1/2" x 77 1/2" 8068 = 48 1/2" x 77 1/2" 5080 = 30 1/2" x 93 1/2" 6080 = 36 1/2" x 93 1/2" 6480 = 38 1/2" x 93 1/2" |
| OPTIONS GLASS: | | | |
| CLEAR (STANDARD) | • | • | • |
| LOW-E WITH ARGON | • | • | • |
| ULTRA LOW-E WITH ARGON | • | • | • |
| OPTIONS GAS: | | | |
| ARGON | • | • | • |

312 Thermal Performance

| Climate Zone | Low-E Surface 2 | Low-E Surface 4 | Spacer | Gas | Foam | DS | U-Value | SHGC | | VT | |
|------------------------|-----------------|-----------------|---------------|-------|---------|----|---------|------|---------|------|---------|
| | | | | | | | | Grid | No Grid | Grid | No Grid |
| North North Central | 270 | i89 | Intercept Tin | Argon | No Foam | DS | 0.25 | 0.27 | 0.30 | 0.49 | 0.56 |
| South South Central | 366 | i89 | Intercept Tin | Argon | No Foam | DS | 0.25 | 0.20 | 0.22 | 0.45 | 0.52 |





332 Thermal Performance

| GLASS/GRID | 332 STANDARD SIZE | | 332 CUSTOM SIZE | |
|-------------------------------------|-------------------|------|-----------------|------|
| | U-Value | SHGC | U-Value | SHGC |
| DS Clear Glass No Grid | 0.47 | 0.63 | 0.47 | 0.63 |
| DS Low-E Glass No Grid | 0.33 | 0.30 | 0.33 | 0.30 |
| DS Low-E/Argon Glass No Grid | 0.30 | 0.30 | 0.30 | 0.30 |
| DS Ultra Low-E/Argon No Grid | 0.30 | 0.22 | 0.29 | 0.22 |
| DS Clear Glass with Grid | 0.47 | 0.55 | 0.47 | 0.55 |
| DS Low-E Glass with Grid | 0.33 | 0.27 | 0.33 | 0.27 |
| DS Low-E/Argon Glass with Grid | 0.30 | 0.27 | 0.30 | 0.27 |
| DS Ultra Low-E/Argon with Grid | 0.30 | 0.20 | 0.29 | 0.20 |
| DS Clear Glass with SDL | 0.47 | 0.49 | 0.47 | 0.49 |
| DS Low-E Glass with SDL | 0.33 | 0.27 | 0.33 | 0.27 |
| DS Low-E/Argon Glass with SDL | 0.30 | 0.27 | 0.30 | 0.27 |
| DS Ultra Low-E/Argon Glass with SDL | 0.29 | 0.20 | 0.29 | 0.20 |

SLIDING PATIO DOORS

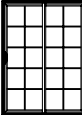
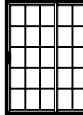
311, 312, and 332 Sliding Patio Doors Size Chart

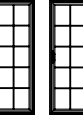
| ROUGH OPENING | 60" | 72" | 76" | 96" | 108" | 144" | 140" |
|------------------------|-------|--------|--------|-------|---------|---------|----------|
| EXACT SIZE WITHOUT FIN | 58.75 | 70.75" | 74.75" | 94.75 | 107.5" | 143.5" | 139.875" |
| OPENING WIDTH | 59.5" | 71.5" | 75.5" | 95.5" | 108.25" | 144.25" | 140.625" |

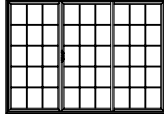
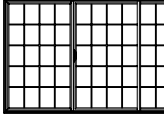
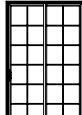
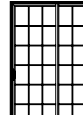
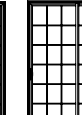
| HEIGHT | 80" | | | | | | |
|--------|---|---|---|---|---|--|---|
| | 5068 | 6068 | 6468 | 8068 | 9068 | 12068 (3 PANEL) | 12068 (4 PANEL) |
| 79.5" |  |  |  |  |  |  |  |
| 96.0" |  |  |  | | | | |

Notes: 1. 311 only available in 5068, 6068 and 6468 sizes.
 2. 5080, 6080 and 6480 only available in 332.

Foamed PVC Jamb Extension Kits:

The interior foamed PVC jamb extension kit is available in pre-primed pine or stainable for your convenience and ease of installation. The extension creates an overall frame thickness of 4 9/16" or 6 9/16". Note: Series 332 has a 4 9/16" jamb as standard.

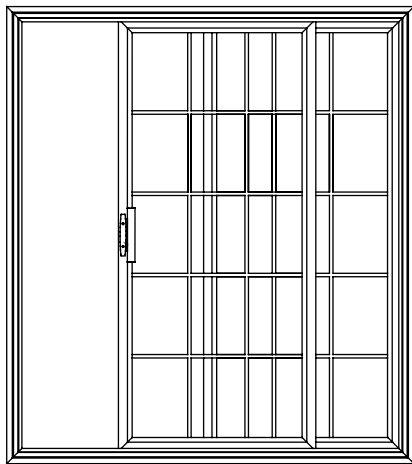

INTERIOR VIEW OF DOOR WITH COLONIAL GRID PARTIALLY OPEN

Recommended Rough Opening:

Width = Door Width (DW) + 3/4"
 Height = Door Height (DO) + 1/2"

SLIDING PATIO DOORS

Series 311 vertical diagram

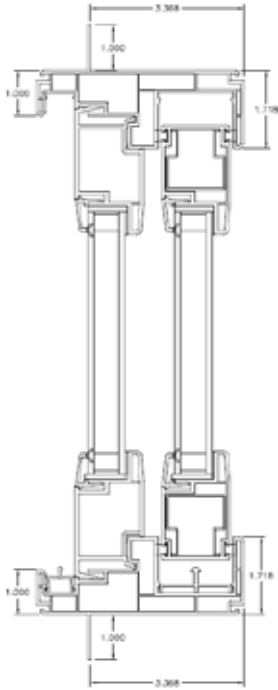

Series 312 vertical diagram

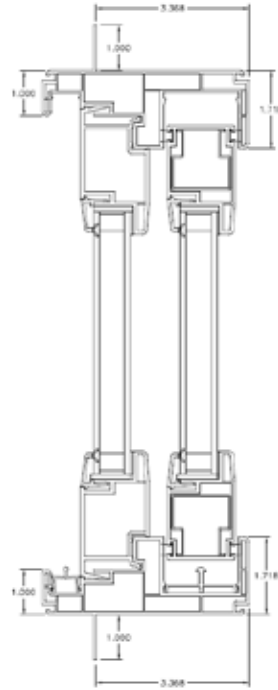

Series 332 vertical diagram

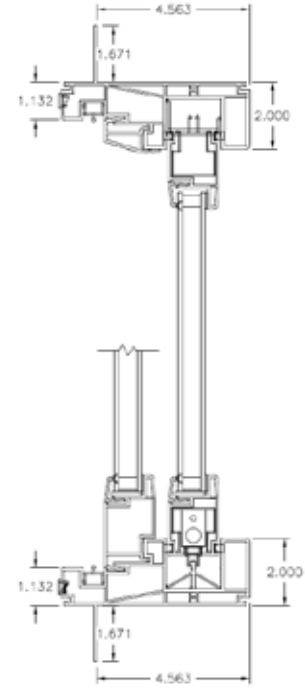

Series 311 horizontal diagram

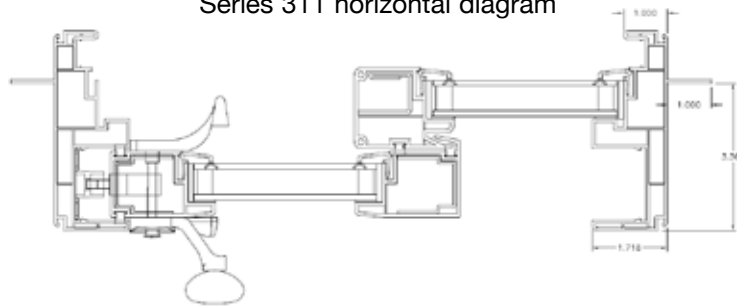

Series 312 horizontal diagram

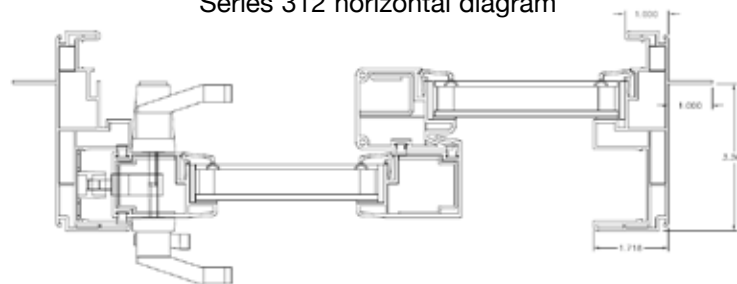

Series 332 horizontal diagram

